



2026.1

НОВИНКИ

СОДЕРЖАНИЕ

РАЗДЕЛ 1. НОВОЕ СЕМЕЙСТВО ТОКАРНЫХ ПЛАСТИН ДЛЯ ОБРАБОТКИ ТРУДНООБРАБАТЫВАЕМЫХ МАТЕРИАЛОВ	5
--	---

РАЗДЕЛ 2. «LightBreeze» СВЁРЛА СО СМЕННЫМИ ГОЛОВКАМИ С ЦИЛИНДРИЧЕСКОЙ НОЖКОЙ	25
--	----

РАЗДЕЛ 3. МОДУЛЬНЫЕ СИСТЕМЫ СВЕРЛЕНИЯ «ModLine», «ModLine-M»	45
---	----

РАЗДЕЛ 4. ВЫСОКОПРОИЗВОДИТЕЛЬНЫЕ ФРЕЗЫ ДЛЯ ВЫСОКОСКОРОСТНОЙ ОБРАБОТКИ АЛЮМИНИЯ И СПЛАВОВ ЦВЕТНЫХ МЕТАЛЛОВ	63
---	----

РАЗДЕЛ 5. ФРЕЗЫ СО СМЕННЫМИ ТВЕРДОСПЛАВНЫМИ ПЛАСТИНАМИ (ОБРАБОТКА ГРУПП МАТЕРИАЛОВ P, M, K, S, H)	73
---	----

РАЗДЕЛ 6. ХВОСТОВИКИ ТВЕРДОСПЛАВНЫЕ	89
--	----

РАЗДЕЛ 7. ФРЕЗЫ ИЗ БЫСТРОРЕЖУЩИХ СТАЛЕЙ	93
--	----

РАЗДЕЛ 8. БОРФРЕЗЫ	103
-----------------------	-----





В рамках торговой марки «ИЗ ВОСХОД» разрабатывается широкий ассортимент токарных пластин, в основе которого лежит обработка труднообрабатываемых материалов: нержавеющие стали, титановые сплавы, жаропрочные сплавы на основе никеля и т. д. Конкретные номенклатурные позиции будут доступны по мере их разработки и запуска в производство.



**РАЗДЕЛ 1.
НОВОЕ СЕМЕЙСТВО ТОКАРНЫХ
ПЛАСТИН ДЛЯ ОБРАБОТКИ
ТРУДНООБРАБАТЫВАЕМЫХ
МАТЕРИАЛОВ**

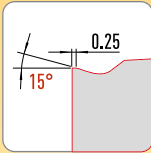

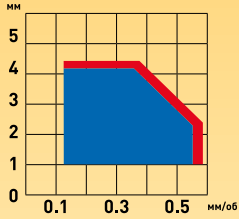
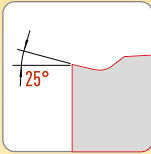
	Обозначение	Описание	Геометрии		P M K N S H	Режимы
ЧИСТОВЫЕ	NAU	Очень острая режущая кромка. Высокая стойкость к истиранию. Основное применение: чистовая обработка сталей, нержавеющей сталей, титановых и жаропрочных сплавов.				
	NS	Основное применение: для нержавеющей сталей, титановых и суперсплавов, закаленных сталей и низкоуглеродистых сталей.				
	NU	Основное применение: для нержавеющей сталей, титановых и суперсплавов, закаленных сталей и низкоуглеродистых сталей.				
ЧИСТОВЫЕ И ПОЛУЧИСТОВЫЕ	RNCM	Острая режущая кромка. Высокая стойкость к истиранию. Применяется для получистовой и чистовой обработки.				
	NCF	Острая режущая кромка. Хорошее формирование стружки. Лучший выбор для обработки нержавеющей сталей, титановых сплавов, жаропрочных сплавов, низкоуглеродистой стали				
	NCTM	Острая режущая кромка. Хорошее формирование стружки, высокая износостойкость. Основное применение: получистовая обработка сталей.				
	NMR	Мощная режущая кромка. Хорошее формирование стружки. Применение: получистовая обработка сталей и чугунов (с шаровидным графитом и на основе никеля).				
	NGH	Мощная режущая кромка. Основное применение: черновая обработка сталей и чугунов.				

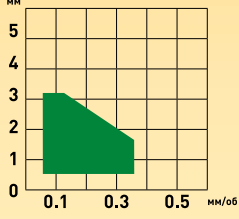
	Обозначение	Описание	Геометрии		P M K N S H	Режимы
ЧЕРНОВЫЕ	NTC	Мощная режущая кромка. Применяется для черновой обработки сталей.				
ЧИСТОВЫЕ И ПОЛУЧИСТОВЫЕ	NAL	Острая режущая кромка. Хорошее формирование стружки. Основное применение: получистовая и чистовая обработка алюминиевых сплавов.				

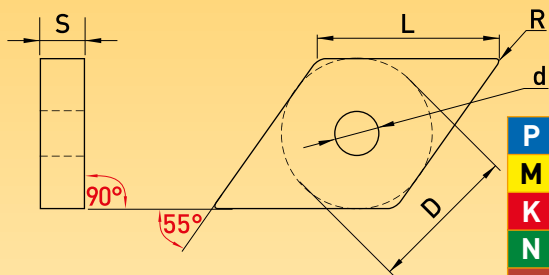

P	★	★	★	★													★
M								★	★	★	★	★	★				★
K	★	★			★	★											★
N																	★
S								★	★	★	★			★	★		
H		★												★	★		

Обработка	Артикул	L мм	D мм	S мм	d мм	R мм	СПЛАВЫ										без покрытия					
							с покрытием															
							RP15	RP25	RP30	RPK35	RK10	RMS30	RMS30A	RMS25	RMS25C	RU30	RU30F	RMT20	VM25	RN20		
Чистовая и полушлифовая	DNMG150404-RNCM	15.5	12.700	4.76	5.16	0.4						○	○	○	○	○		○				
	DNMG150408-RNCM	15.5	12.700	4.76	5.16	0.8						○	○	○	○	○		○				
	DNMG150604-RNCM	15.5	12.700	6.35	5.16	0.4						○	○	○	○	○		○				
	DNMG150608-RNCM	15.5	12.700	6.35	5.16	0.8						○	○	○	○	○		○				
	DNMG110404-NCF	11.6	9.525	4.76	3.81	0.4				○		○	○	○	○	○	○		○			
	DNMG110408-NCF	11.6	9.525	4.76	3.81	0.8				○		○	○	○	○	○	○		○			
	DNMG150404-NCF	15.5	12.700	4.76	5.16	0.4				○		○	○	○	○	○	○		○			
	DNMG150408-NCF	15.5	12.700	4.76	5.16	0.8				○		○	○	○	○	○	○		○			
	DNMG150604-NCF	15.5	12.700	6.35	5.16	0.4				○		○	○	○	○	○	○		○			
	DNMG150608-NCF	15.5	12.700	6.35	5.16	0.8				○		○	○	○	○	○	○		○			
	DNMG150604-NBF	15.0	12.700	6.35	5.16	0.4														○		
	DNMG150608-NBF	15.0	12.700	6.35	5.16	0.8														○		
	DNMG150404-NCTM	15.5	12.700	4.76	5.16	0.4		○	○	○												
	DNMG150408-NCTM	15.5	12.700	4.76	5.16	0.8		○	○	○												
	DNMG150604-NCTM	15.5	12.700	6.35	5.16	0.4		○	○	○												
	DNMG150608-NCTM	15.5	12.700	6.35	5.16	0.8		○	○	○												
	DNMG110404-NMR	11.6	9.525	4.76	3.81	0.4		○		○												
	DNMG110408-NMR	11.6	9.525	4.76	3.81	0.8		○		○												
DNMG150404-NMR	15.5	12.700	4.76	5.16	0.4		○		○													
DNMG150408-NMR	15.5	12.700	4.76	5.16	0.8		○		○													
DNMG150604-NMR	15.5	12.700	6.35	5.16	0.4		○		○													
DNMG150608-NMR	15.5	12.700	6.35	5.16	0.8		○		○													
Черновая	DNMG150408-NGH	15.5	12.700	4.76	5.16	0.8		○														
	DNMG150608-NGH	15.5	12.700	6.35	5.16	0.8		○														
Чистовая и полушлифовая	DNMG150404-NAL	15.5	12.700	4.76	5.16	0.4															○	
	DNMG150408-NAL	15.5	12.700	4.76	5.16	0.8															○	
	DNMG150604-NAL	15.5	12.700	6.35	5.16	0.4															○	
	DNMG150608-NAL	15.5	12.700	6.35	5.16	0.8															○	

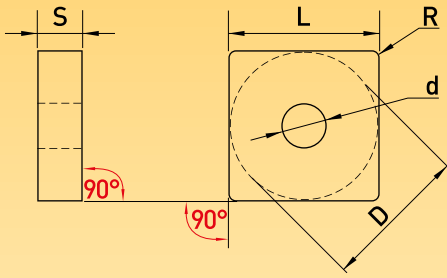

P	★	★	★	★														
M							★	★	★	★	★	★						
K	★	★		★	★													
N																		★
S							★	★	★	★				★	★			
H		★												★	★			

Обработка	Артикул	L мм	D мм	S мм	d мм	R мм	СПЛАВЫ													
							с покрытием											без покрытия		
							RP15	RP25	RP30	RPK35	RK10	RMS30	RMS30A	RMS25	RMS25C	RU30	RU30F	RMT20	RN20	
Чистовая и полужистовая	SNMG120404-RNCM	12.700	12.700	4.760	5.16	0.4						○	○	○	○	○		○		
	SNMG120408-RNCM	12.700	12.700	4.760	5.16	0.8						○	○	○	○	○		○		
	SNMG120412-RNCM	12.700	12.700	4.760	5.16	1.2						○	○	○	○	○		○		
	SNMG120404-NCTM	12.700	12.700	4.760	5.16	0.4	○	○	○											
	SNMG120408-NCTM	12.700	12.700	4.760	5.16	0.8	○	○	○											
	SNMG120412-NCTM	12.700	12.700	4.760	5.16	1.2	○	○	○											
	SNMG120404-NMR	12.700	12.700	4.760	5.16	0.4	○		○											
	SNMG120408-NMR	12.700	12.700	4.760	5.16	0.8	○		○											
	SNMG120412-NMR	12.700	12.700	4.760	5.16	1.2	○		○											
	SNMG150608-NMR	15.875	15.875	6.350	6.35	0.8	○		○											
	SNMG150612-NMR	15.875	15.875	6.350	6.35	1.2	○		○											
	SNMG150616-NMR	15.875	15.875	6.350	6.35	1.6	○		○											
	SNMG150624-NMR	15.875	15.875	6.350	6.35	2.4	○		○											
Черновая	SNMG120408-NGH	12.700	12.700	4.760	5.16	0.8	○				○									
	SNMG120412-NGH	12.700	12.700	4.760	5.16	1.2	○				○									
	SNMG120416-NGH	12.700	12.700	4.760	5.16	1.6	○				○									
	SNMG150612-NGH	15.875	15.875	6.350	6.35	1.2	○				○									
	SNMG190612-NGH	19.050	19.050	6.350	7.94	1.2	○				○									
	SNMG190616-NGH	19.050	19.050	6.350	7.94	1.6	○				○									
	SNMG250724-NGH	25.400	25.400	7.940	9.12	2.4	○				○									
	SNMM190616-NGH	19.050	19.050	6.350	7.94	1.6	○				○									
	SNMM250924-NGH	25.400	25.400	9.525	9.12	2.4	○				○									
	SNMG120408 R/L-NTC	12.700	12.700	4.760	5.16	0.8		○	○	○										
SNMG120412 R/L-NTC	12.700	12.700	4.760	5.16	1.2		○	○	○											

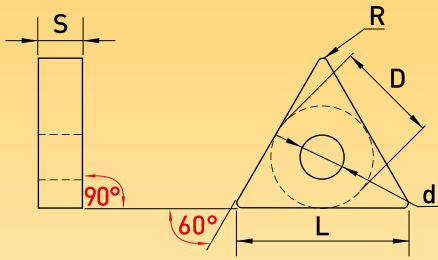

P	★	★	★	★	★	★													
M						★		★	★	★	★	★	★	★					
K	★	★			★			★											
N																			★
S										★	★	★	★			★	★		
H		★														★	★		

Обработка	Артикул	L мм	D мм	S мм	d мм	R мм	СПЛАВЫ															
							с покрытием													без покрытия		
							RP15	RP25	RP30	RPK35	RPC20	RP20	RK10	RMS30	RMS30A	RMS25	RMS25C	RU30	RU30F	RMT20	RN20	
Чистовая	TNMG160404-NAU	16.5	9.525	4.76	3.81	0.40													○	○		
	TNMG160408-NAU	16.5	9.525	4.76	3.81	0.80													○	○		
	TNGG1604005 R/L-NS	16.5	9.525	4.76	3.81	0.05					○	○									○	
	TNGG160401 R/L-NS	16.5	9.525	4.76	3.81	0.10					○	○									○	
	TNGG160402 R/L-NS	16.5	9.525	4.76	3.81	0.20					○	○									○	
	TNGG160401 R/L-NU	16.5	9.525	4.76	3.81	0.10					○	○									○	
	TNGG160402 R/L-NU	16.5	9.525	4.76	3.81	0.20					○	○									○	
Чистовая и полуцифровая	TNMG160404-RNCM	16.5	9.525	4.76	3.81	0.40							○	○	○	○	○			○		
	TNMG160408-RNCM	16.5	9.525	4.76	3.81	0.80							○	○	○	○	○			○		
	TNMG160412-RNCM	16.5	9.525	4.76	3.81	1.20							○	○	○	○	○			○		
	TNMG120304-RNCM	—	—	—	—	0.40							○	○	○	○	○			○		
	TNMG120308-RNCM	—	—	—	—	0.80							○	○	○	○	○			○		
	TNGG160401-NCF	16.5	9.525	4.76	3.81	0.10					○		○	○	○		○	○		○		
	TNGG160402-NCF	16.5	9.525	4.76	3.81	0.20					○		○	○	○		○	○		○		
	TNGG160404-NCF	16.5	9.525	4.76	3.81	0.40					○		○	○	○		○	○		○		
	TNGG160408-NCF	16.5	9.525	4.76	3.81	0.80					○		○	○	○		○	○		○		
	TNMG160404-NCF	16.5	9.525	4.76	3.81	0.40							○	○	○	○	○	○		○	○	
	TNMG160408-NCF	16.5	9.525	4.76	3.81	0.80							○	○	○	○	○	○		○	○	
	TNMG160412-NCF	16.5	9.525	4.76	3.81	1.20							○	○	○	○	○	○		○	○	
	TNMG160404-NCTM	16.5	9.525	4.76	3.81	0.40		○	○	○												
	TNMG160408-NCTM	16.5	9.525	4.76	3.81	0.80		○	○	○												
	TNMG160412-NCTM	16.5	9.525	4.76	3.81	1.20		○	○	○												
	TNMG160404-NMR	16.5	9.525	4.76	3.81	0.40		○		○												
	TNMG160408-NMR	16.5	9.525	4.76	3.81	0.80		○		○												
TNMG220408-NMR	22.0	12.700	4.76	5.16	0.80		○		○													
TNMG220412-NMR	22.0	12.700	4.76	5.16	1.20		○		○													
Черновая	TNMG160408-NGH	16.5	9.525	4.76	3.81	0.80		○													○	
	TNMG160412-NGH	16.5	9.525	4.76	3.81	1.20		○													○	
	TNMG160404 R/L-NTC	16.5	9.525	4.76	3.81	0.40			○	○	○											
TNMG160408 R/L-NTC	16.5	9.525	4.76	3.81	0.80				○	○	○											
TNMG160412 R/L-NTC	16.5	9.525	4.76	3.81	1.20					○	○	○										
Чистовая и полуцифровая	TNMG160404-NAL	16.5	9.525	4.76	3.81	0.40															○	
	TNMG160408-NAL	16.5	9.525	4.76	3.81	0.80															○	

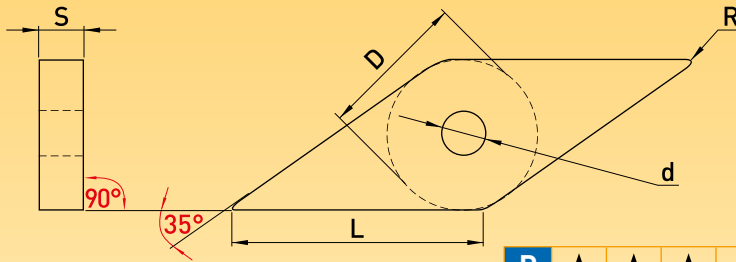

P	★	★	★	★	★	★												
M						★		★	★	★	★	★	★	★				
K	★	★		★			★											
N																		★
S											★	★	★	★		★	★	
H		★														★	★	

Обработка	Артикул	L мм	D мм	S мм	d мм	R мм	СПЛАВЫ												без покрытия			
							с покрытием															
							RP15	RP25	RP30	RPK35	RPC20	RP20	RK10	RMS30	RMS30A	RMS25	RMS25C	RU30	RU30F	RMT20	RN20	
Чистовая и полужистовая	VNMG160404-RNCM	16.6	9.525	4.76	3.81	0.4								○	○	○	○	○		○		
	VNMG160408-RNCM	16.6	9.525	4.76	3.81	0.8								○	○	○	○	○		○		
	VNMG160412-RNCM	16.6	9.525	4.76	3.81	1.2								○	○	○	○	○		○		
	VNMG12T304-NCF	12.4	7.150	3.97	3.56	0.4				○				○	○	○	○	○	○	○	○	
	VNMG12T308-NCF	12.4	7.150	3.97	3.56	0.8				○				○	○	○	○	○	○	○	○	
	VNMG160404-NCF	16.6	9.525	4.76	3.81	0.4				○				○	○	○	○	○	○	○	○	
	VNMG160408-NCF	16.6	9.525	4.76	3.81	0.8				○				○	○	○	○	○	○	○	○	
	VNMG160404-NCTM	16.6	9.525	4.76	3.81	0.4	○	○	○													
	VNMG160408-NCTM	16.6	9.525	4.76	3.81	0.8	○	○	○													
	VNMG160412-NCTM	16.6	9.525	4.76	3.81	1.2	○	○	○													
	VNMG160404-NMR	16.6	9.525	4.76	3.81	0.4	○		○													
	VNMG160408-NMR	16.6	9.525	4.76	3.81	0.8	○		○													
Черновая	VNMG160408-NGH	16.6	9.525	4.76	3.81	0.8	○							○								
	VNMG160412-NGH	16.6	9.525	4.76	3.81	1.2	○							○								
Чистовая и полужистовая	VNMG160404-NAL	16.6	9.525	4.76	3.81	0.4																○
	VNMG160408-NAL	16.6	9.525	4.76	3.81	0.8																○

Обозначение	Описание	Геометрии		P M K N S H	Режимы	
ЧИСТОВЫЕ	PCF	Высокопозитивная геометрия с передним углом 14–20°. Хорошее формирование стружки. Чистовая и получистовая обработка. Лучший выбор для нержавеющих сталей, титановых и жаропрочных сплавов, термообработанных сталей и низкоуглеродистых сталей.				
	PS	Основное применение: для нержавеющих сталей, титановых и суперсплавов, закаленных сталей и низкоуглеродистых сталей.				
	PY	Основное применение: для нержавеющих сталей, титановых и жаропрочных сплавов, закаленных сталей и низкоуглеродистых сталей.				
	PU	Основное применение: для нержавеющих сталей, титановых и суперсплавов, закаленных сталей и низкоуглеродистых сталей.				
ЧИСТОВЫЕ И ПОЛУЧИСТОВЫЕ	PCM	Позитивная геометрия с передним углом 8°. Хорошее формирование стружки. Высокая стойкость к истиранию. Чистовая и получистовая обработка материалов группы PMS.				
	PMX	Острая режущая кромка. Хорошее формирование стружки, высокая износостойкость. Основное применение: получистовая обработка сталей.				
	PAL	Острая режущая кромка. Хорошее формирование стружки. Основное применение: получистовая и чистовая обработка алюминиевых сплавов, нержавеющих сталей, сталей, титановых и супер сплавов.				

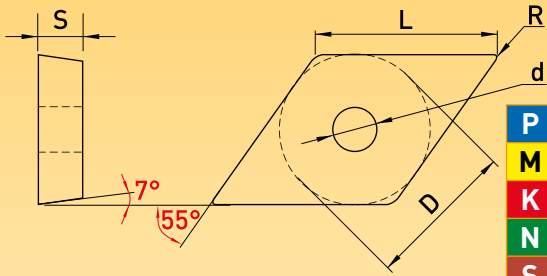

P	★	★	★	★	★	★												
M						★		★	★	★	★	★	★	★	★			
K	★	★		★				★										
N																		★
S									★	★	★	★				★	★	
H		★														★	★	

Обработка	Артикул	L мм	D мм	S мм	d мм	R мм	СПЛАВЫ																		
							с покрытием											без покрытия							
							RP15	RP25	RP30	RPK35	RPC20	RP20	RK10	RMS30	RMS30A	RMS25	RMS25C		RU15	RU30	RU30F	RMT20	RN20		
Чистовая	DCGT070201-PCF	7.8	6.350	2.38	2.8	0.10												○							
	DCGT070202-PCF	7.8	6.350	2.38	2.8	0.20													○						
	DCGT11T301-PCF	11.6	9.525	3.97	4.4	0.10													○						
	DCGT11T302-PCF	11.6	9.525	3.97	4.4	0.20													○						
	DCGT11T304-PCF	11.6	9.525	3.97	4.4	0.40													○						
	DCGT0702005 R/L-PS	7.8	6.350	2.38	2.8	0.05					○	○													○
	DCGT070201 R/L-PS	7.8	6.350	2.38	2.8	0.10					○	○													○
	DCGT070202 R/L-PS	7.8	6.350	2.38	2.8	0.20					○	○													○
	DCGT070204 R/L-PS	7.8	6.350	2.38	2.8	0.40					○	○													○
	DCGT11T3005 R/L-PS	11.6	9.525	3.97	4.4	0.05					○	○													○
	DCGT11T301 R/L-PS	11.6	9.525	3.97	4.4	0.10					○	○													○
	DCGT11T302 R/L-PS	11.6	9.525	3.97	4.4	0.20					○	○													○
	DCGT11T304 R/L-PS	11.6	9.525	3.97	4.4	0.40					○	○													○
	DCGT0702005 R/L-PY	7.8	6.350	2.38	2.8	0.05					○	○													○
	DCGT070201 R/L-PY	7.8	6.350	2.38	2.8	0.10					○	○													○
	DCGT070202 R/L-PY	7.8	6.350	2.38	2.8	0.20					○	○													○
	DCGT070204 R/L-PY	7.8	6.350	2.38	2.8	0.40					○	○													○
	DCGT11T3005 R/L-PY	11.6	9.525	3.97	4.4	0.05					○	○													○
	DCGT11T301 R/L-PY	11.6	9.525	3.97	4.4	0.10					○	○													○
	DCGT11T302 R/L-PY	11.6	9.525	3.97	4.4	0.20					○	○													○
	DCGT11T304 R/L-PY	11.6	9.525	3.97	4.4	0.40					○	○													○
	DCGT0702005 R/L-PU	7.8	6.350	2.38	2.8	0.05					○	○													○
	DCGT070201 R/L-PU	7.8	6.350	2.38	2.8	0.10					○	○													○
	DCGT070202 R/L-PU	7.8	6.350	2.38	2.8	0.20					○	○													○
DCGT070204 R/L-PU	7.8	6.350	2.38	2.8	0.40					○	○													○	
DCGT11T3005 R/L-PU	11.6	9.525	3.97	4.4	0.05					○	○													○	
DCGT11T301 R/L-PU	11.6	9.525	3.97	4.4	0.10					○	○													○	
DCGT11T302 R/L-PU	11.6	9.525	3.97	4.4	0.20					○	○													○	
DCGT11T304 R/L-PU	11.6	9.525	3.97	4.4	0.40					○	○													○	

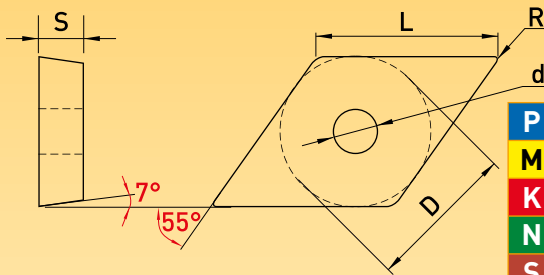

P	★	★	★	★	★	★													
M						★		★	★	★	★	★	★	★	★	★			
K	★	★		★			★												
N																			★
S									★	★	★	★				★	★		
H		★														★	★		

Обработка	Артикул	L мм	D мм	S мм	d мм	R мм	СПЛАВЫ															
							с покрытием												без покрытия			
							RP15	RP25	RP30	RPK35	RPC20	RP20	RK10	RMS30	RMS30A	RMS25	RMS25C	RU15	RU30	RU30F	RMT20	RN20
Чистовая и полужирная	DCGT070202-PCM	7.8	6.350	2.38	2.8	0.20								○		○	○		○	○	○	
	DCGT070204-PCM	7.8	6.350	2.38	2.8	0.40								○		○	○		○	○	○	
	DCGT11T302-PCM	11.6	9.525	3.97	4.4	0.20								○		○	○		○	○	○	
	DCGT11T304-PCM	11.6	9.525	3.97	4.4	0.40								○		○	○		○	○	○	
	DCMT070202-PCM	7.8	6.350	2.38	2.8	0.20								○		○	○		○	○	○	
	DCMT070204-PCM	7.8	6.350	2.38	2.8	0.40								○		○	○		○	○	○	
	DCMT11T302-PCM	11.6	9.525	3.97	4.4	0.20								○		○	○		○	○	○	
	DCMT11T304-PCM	11.6	9.525	3.97	4.4	0.40								○		○	○		○	○	○	
	DCGT070204-PMX	7.8	6.350	2.38	2.8	0.40								○					○		○	
	DCGT070208-PMX	7.8	6.350	2.38	2.8	0.80								○					○		○	
	DCGT11T304-PMX	11.6	9.525	3.97	4.4	0.40								○					○		○	
	DCGT11T308-PMX	11.6	9.525	3.97	4.4	0.80								○					○		○	
	DCMT070204-PMX	7.8	6.350	2.38	2.8	0.40								○					○		○	
	DCMT070208-PMX	7.8	6.350	2.38	2.8	0.80								○					○		○	
	DCMT11T304-PMX	11.6	9.525	3.97	4.4	0.40								○					○		○	
	DCMT11T308-PMX	11.6	9.525	3.97	4.4	0.80								○					○		○	
	DCGT0702005-PAL	7.8	6.350	2.38	2.8	0.05					○			○				○				○
	DCGT070201-PAL	7.8	6.350	2.38	2.8	0.10					○			○				○				○
	DCGT070202-PAL	7.8	6.350	2.38	2.8	0.20					○			○				○				○
	DCGT070204-PAL	7.8	6.350	2.38	2.8	0.40					○			○				○				○
	DCGT11T3005-PAL	11.6	9.525	3.97	4.4	0.05					○			○				○				○
	DCGT11T301-PAL	11.6	9.525	3.97	4.4	0.10					○			○				○				○
	DCGT11T302-PAL	11.6	9.525	3.97	4.4	0.20					○			○				○				○
	DCGT11T304-PAL	11.6	9.525	3.97	4.4	0.40					○			○				○				○

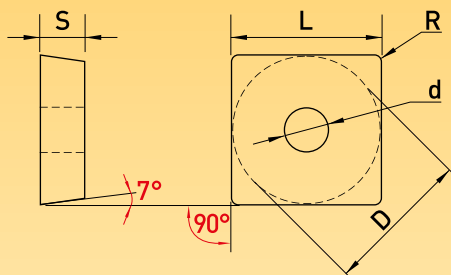

P	★	★	★	★	★	★													
M						★		★	★	★	★	★	★	★	★				
K	★	★		★			★												
N																			★
S									★	★	★	★				★	★		
H		★														★	★		

Обработка	Артикул	L мм	D мм	S мм	d мм	R мм	СПЛАВЫ															
							с покрытием													без покрытия		
							RP15	RP25	RP30	RPK35	RPC20	RP20	RK10	RMS30	RMS30A	RMS25	RMS25C	RU15	RU30	RU30F	RMT20	RN20
Чистовая и полуставовая	SCMT09T304-PCM	9.525	9.525	3.97	4.4	0.4								○		○	○		○	○	○	
	SCMT09T308-PCM	9.525	9.525	3.97	4.4	0.8								○		○	○		○	○	○	
	SCGT09T304-PMX	9.525	9.525	3.97	4.4	0.4								○					○		○	
	SCGT09T308-PMX	9.525	9.525	3.97	4.4	0.8								○					○		○	
	SCGT120404-PMX	12.700	12.700	4.76	5.5	0.4								○					○		○	
	SCGT120408-PMX	12.700	12.700	4.76	5.5	0.8								○					○		○	
	SCGT120412-PMX	12.700	12.700	4.76	5.5	1.2								○					○		○	
	SCMT09T304-PMX	9.525	9.525	3.97	4.4	0.4								○					○		○	
	SCMT09T308-PMX	9.525	9.525	3.97	4.4	0.8								○					○		○	
	SCMT120404-PMX	12.700	12.700	4.76	5.5	0.4								○					○		○	
	SCMT120408-PMX	12.700	12.700	4.76	5.5	0.8								○					○		○	
	SCMT120412-PMX	12.700	12.700	4.76	5.5	1.2								○					○		○	

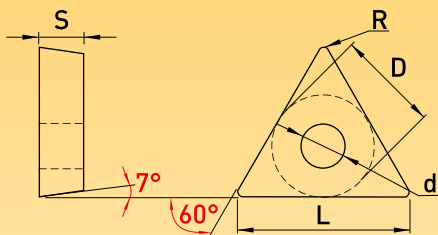

P	★	★	★	★	★	★													
M						★		★	★	★	★	★	★	★					
K	★	★		★			★												
N																			★
S								★	★	★	★				★	★			
H		★													★	★			

Обработка	Артикул	L мм	D мм	S мм	d мм	R мм	СПЛАВЫ																	
							с покрытием														без покрытия			
							RP15	RP25	RP30	RPK35	RPC20	RP20	RK10	RMS30	RMS30A	RMS25	RMS25C	RU15	RU30	RU30F	RMT20	RN20		
Чистовая и получистовая	TCGT110202-PCM	11.0	6.350	2.38	2.8	0.2									○			○	○		○	○	○	
	TCGT110204-PCM	11.0	6.350	2.38	2.8	0.4									○			○	○		○	○	○	
	TCGT110208-PCM	11.0	6.350	2.38	2.8	0.8									○			○	○		○	○	○	
	TCMT110202-PCM	11.0	6.350	2.38	2.8	0.2									○			○	○		○	○	○	
	TCMT110204-PCM	11.0	6.350	2.38	2.8	0.4									○			○	○		○	○	○	
	TCMT110208-PCM	11.0	6.350	2.38	2.8	0.8									○			○	○		○	○	○	
	TCGT110204-PMX	11.0	6.350	2.38	2.8	0.4									○			○	○		○	○	○	
	TCGT110208-PMX	11.0	6.350	2.38	2.8	0.8									○			○	○		○	○	○	
	TCGT16T304-PMX	16.5	9.525	3.97	4.4	0.4									○			○	○		○	○	○	
	TCGT16T308-PMX	16.5	9.525	3.97	4.4	0.8									○			○	○		○	○	○	
	TCMT110204-PMX	11.0	6.350	2.38	2.8	0.4									○			○	○		○	○	○	
	TCMT110208-PMX	11.0	6.350	2.38	2.8	0.8									○			○	○		○	○	○	
	TCMT16T304-PMX	16.5	9.525	3.97	4.4	0.4									○			○	○		○	○	○	
	TCMT16T308-PMX	16.5	9.525	3.97	4.4	0.8									○			○	○		○	○	○	



**РАЗДЕЛ 2.
СВЁРЛА СО СМЕННЫМИ ГОЛОВКАМИ
С ЦИЛИНДРИЧЕСКОЙ НОЖКОЙ**

«LightBreeze»



Торговая марка «ИЗ ВОСХОД» представляет новую серию свёрл «LightBreeze» со сменными головками с цилиндрической ножкой

Данная серия разработана с целью повышения производительности и увеличению срока службы инструмента и обладает рядом неоспоримых преимуществ:

- легкость и удобство замены сменной головки: замена производится без снятия корпуса сверла со станка;
- жесткость и точность позиционирования достигается комбинацией конической посадки и цилиндрической формой ножки;
- оптимизированная геометрия головки позволяет сверление с высокой подачей;
- наличие в ассортименте различных вариантов твердосплавных головок и головок из порошковой быстрорежущей стали;
- сверление в широком диапазоне обрабатываемых материалов;
- высокоскоростное сверление на станках с ЧПУ так и на универсальных станках;
- специальная геометрия стружководводящих канавок улучшает отвод стружки;
- повышенная жесткость корпуса и увеличенный срок службы.

Стандартная линейка диаметров от 10 до 40 мм.

ГЛУБИНЫ СВЕРЛЕНИЯ				
3D	5D	8D	10D	12D
СТАНДАРТ	СТАНДАРТ	СТАНДАРТ	СПЕЦИАЛЬНЫЙ ЗАКАЗ	СПЕЦИАЛЬНЫЙ ЗАКАЗ

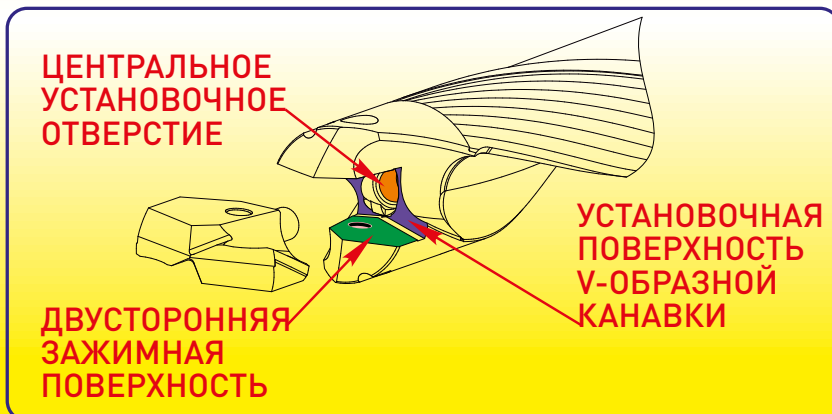
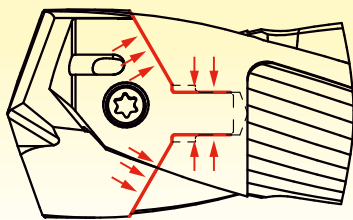

СВЁРЛА СО СМЕННЫМИ ГОЛОВКАМИ С ЦИЛИНДРИЧЕСКОЙ НОЖКОЙ. Хвостовик ISO 9766

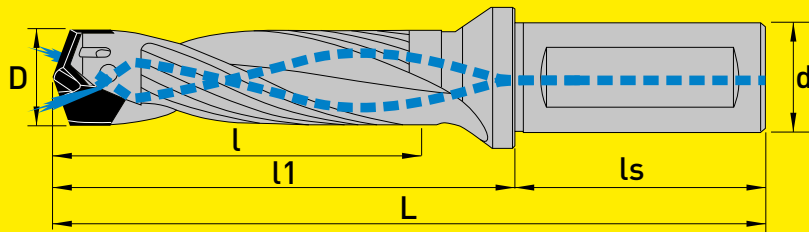

Диапазон сверления D	Артикул	Глубина сверления	l мм	ls мм	l1 мм	L мм	d мм
10.0~10.49	LBD10010403W16H	3D	31.5	48	48	96	16
	LBD10010405W16H	5D	52.5	48	69	117	16
	LBD10010408W16H	8D	84.0	48	100	148	16
	LBD10010410W16H	10D	104.0	48	121	169	16
	LBD10010412W16H	12D	125.0	48	142	190	16
10.5~10.99	LBD10510903W16H	3D	33.0	48	50	98	16
	LBD10510905W16H	5D	55.0	48	72	120	16
	LBD10510908W16H	8D	88.0	48	105	153	16
	LBD10510910W16H	10D	109.0	48	126	174	16
	LBD10510912W16H	12D	131.0	48	148	196	16
11.0~11.49	LBD11011403W16H	3D	34.5	48	52	100	16
	LBD11011405W16H	5D	57.5	48	75	123	16
	LBD11011408W16H	8D	92.0	48	110	158	16
	LBD11011410W16H	10D	114.0	48	132	180	16
	LBD11011412W16H	12D	137.0	48	155	203	16
11.5~11.99	LBD11511903W16H	3D	36.0	48	54	102	16
	LBD11511905W16H	5D	60.0	48	78	126	16
	LBD11511908W16H	8D	96.0	48	114	162	16
	LBD11511910W16H	10D	119.0	48	138	186	16
	LBD11511912W16H	12D	143.0	48	162	210	16
12.0~12.49	LBD12012403W16H	3D	37.5	48	57	105	16
	LBD12012405W16H	5D	62.5	48	82	130	16
	LBD12012408W16H	8D	100.0	48	119	167	16
	LBD12012410W16H	10D	124.0	48	144	192	16
	LBD12012412W16H	12D	149.0	48	169	217	16
12.5~12.99	LBD12512903W16H	3D	39.0	48	59	107	16
	LBD12512905W16H	5D	65.0	48	85	133	16
	LBD12512908W16H	8D	104.0	48	124	172	16
	LBD12512910W16H	10D	129.0	48	149	197	16
	LBD12512912W16H	12D	155.0	48	175	223	16
13.0~13.49	LBD13013403W16H	3D	40.5	48	61	109	16
	LBD13013405W16H	5D	67.5	48	88	136	16
	LBD13013408W16H	8D	108.0	48	128	176	16
	LBD13013410W16H	10D	134.0	48	155	203	16
	LBD13013412W16H	12D	161.0	48	182	230	16
13.5~13.99	LBD13513903W16H	3D	42.0	48	63	111	16
	LBD13513905W16H	5D	70.0	48	91	139	16
	LBD13513908W16H	8D	112.0	48	133	181	16
	LBD13513910W16H	10D	139.0	48	161	209	16
	LBD13513912W16H	12D	167.0	48	189	237	16
14.0~14.49	LBD14014403W16H	3D	43.5	48	65	113	16
	LBD14014405W16H	5D	72.5	48	94	142	16
	LBD14014408W16H	8D	116.0	48	138	186	16
	LBD14014410W20H	10D	144.0	50	165	215	20
	LBD14014412W20H	12D	173.0	50	194	244	20

СВЁРЛА СО СМЕННЫМИ ГОЛОВКАМИ С ЦИЛИНДРИЧЕСКОЙ НОЖКОЙ. Хвостовик ISO 9766

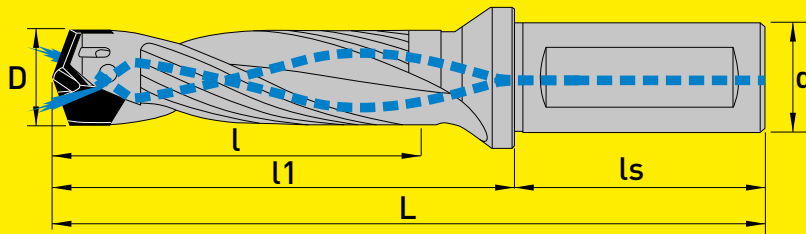

ПРОДОЛЖЕНИЕ ТАБЛИЦЫ

Диапазон сверления	Артикул	Глубина сверления	l мм	ls мм	l1 мм	L мм	d мм
14.5~14.99	LBD14514903W16H	3D	45	48	67	115	16
	LBD14514905W16H	5D	75	48	97	145	16
	LBD14514908W16H	8D	120	48	142	190	16
	LBD14514910W20H	10D	149	50	170	220	20
	LBD14514912W20H	12D	179	50	200	250	20
15.0~15.99	LBD15015903W20H	3D	48	50	72	122	20
	LBD15015905W20H	5D	80	50	104	154	20
	LBD15015908W20H	8D	128	50	152	202	20
	LBD15015910W20H	10D	159	50	184	234	20
	LBD15015912W20H	12D	191	50	216	266	20
16.0~16.99	LBD16016903W20H	3D	51	50	77	127	20
	LBD16016905W20H	5D	85	50	111	161	20
	LBD16016908W20H	8D	136	50	162	212	20
	LBD16016910W20H	10D	169	50	195	245	20
	LBD16016912W20H	12D	203	50	229	279	20
17.0~17.99	LBD17017903W20H	3D	54	50	81	131	20
	LBD17017905W20H	5D	90	50	117	167	20
	LBD17017908W20H	8D	144	50	171	221	20
	LBD17017910W20H	10D	179	50	207	257	20
	LBD17017912W20H	12D	215	50	243	293	20
18.0~18.99	LBD18018903W25H	3D	57	56	85	141	25
	LBD18018905W25H	5D	95	56	123	179	25
	LBD18018908W25H	8D	152	56	180	236	25
	LBD18018910W25H	10D	189	56	213	269	25
	LBD18018912W25H	12D	227	56	250	306	25
19.0~19.99	LBD19019903W25H	3D	60	56	90	146	25
	LBD19019905W25H	5D	100	56	130	186	25
	LBD19019908W25H	8D	160	56	190	246	25
	LBD19019910W25H	10D	199	56	230	286	25
	LBD19019912W25H	12D	239	56	270	326	25
20.0~20.99	LBD20020903W25H	3D	63	56	94	150	25
	LBD20020905W25H	5D	105	56	136	192	25
	LBD20020908W25H	8D	168	56	199	255	25
	LBD20020910W25H	10D	209	56	241	297	25
	LBD20020912W25H	12D	251	56	283	339	25
21.0~21.99	LBD21021903W25H	3D	66	56	98	154	25
	LBD21021905W25H	5D	110	56	142	198	25
	LBD21021908W25H	8D	176	56	208	264	25
	LBD21021910W25H	10D	219	56	253	309	25
	LBD21021912W25H	12D	263	56	297	353	25
22.0~22.99	LBD22022903W25H	3D	69	56	102	158	25
	LBD22022905W25H	5D	115	56	148	204	25
	LBD22022908W25H	8D	184	56	217	273	25
	LBD22022910W25H	10D	229	56	264	320	25
	LBD22022912W25H	12D	275	56	310	366	25

СВЁРЛА СО СМЕННЫМИ ГОЛОВКАМИ С ЦИЛИНДРИЧЕСКОЙ НОЖКОЙ. Хвостовик ISO 9766

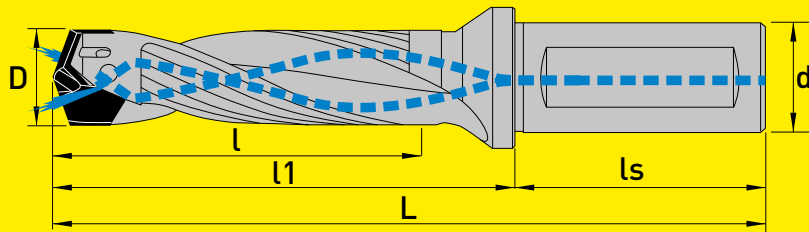

ПРОДОЛЖЕНИЕ ТАБЛИЦЫ

Диапазон сверления	Артикул	Глубина сверления	l мм	ls мм	l1 мм	L мм	d мм
23.0~23.99	LBD23023903W25H	3D	72	56	107	163	25
	LBD23023905W25H	5D	120	56	155	211	25
	LBD23023908W25H	8D	192	56	227	283	25
	LBD23023910W25H	10D	239	56	276	332	25
	LBD23023912W25H	12D	287	56	324	380	25
24.0~24.99	LBD24024903W32H	3D	75	60	112	172	32
	LBD24024905W32H	5D	125	60	162	222	32
	LBD24024908W32H	8D	200	60	237	297	32
	LBD24024910W32H	10D	249	60	287	347	32
	LBD24024912W32H	12D	299	60	337	397	32
25.0~25.99	LBD25025903W32H	3D	78	60	116	176	32
	LBD25025905W32H	5D	130	60	168	228	32
	LBD25025908W32H	8D	208	60	246	306	32
	LBD25025910W32H	10D	259	60	299	359	32
	LBD25025912W32H	12D	311	60	351	411	32
26.0~26.99	LBD26026903W32H	3D	81	60	121	181	32
	LBD26026905W32H	5D	135	60	175	235	32
	LBD26026908W32H	8D	216	60	256	316	32
	LBD26026910W32H	10D	269	60	310	370	32
	LBD26026912W32H	12D	323	60	364	424	32
27.0~27.99	LBD27027903W32H	3D	84	60	125	185	32
	LBD27027905W32H	5D	140	60	181	241	32
	LBD27027908W32H	8D	224	60	265	325	32
	LBD27027910W32H	10D	279	60	222	382	32
	LBD27027912W32H	12D	335	60	378	438	32
28.0~28.99	LBD28028903W32H	3D	87	60	129	189	32
	LBD28028905W32H	5D	145	60	187	247	32
	LBD28028908W32H	8D	232	60	274	334	32
	LBD28028910W32H	10D	289	60	333	393	32
	LBD28028912W32H	12D	347	60	391	451	32
29.0~29.99	LBD29029903W32H	3D	90	60	133	193	32
	LBD29029905W32H	5D	150	60	193	253	32
	LBD29029908W32H	8D	240	60	283	343	32
	LBD29029910W32H	10D	299	60	345	405	32
	LBD29029912W32H	12D	359	60	405	465	32
30.0~30.99	LBD30030903W32H	3D	93	60	138	198	32
	LBD30030905W32H	5D	155	60	200	260	32
	LBD30030908W32H	8D	248	60	293	353	32
	LBD30030910W32H	10D	309	60	356	416	32
	LBD30030912W32H	12D	371	60	418	478	32
31.0~31.99	LBD31031903W32H	3D	96	60	142	202	32
	LBD31031905W32H	5D	160	60	206	266	32
	LBD31031908W32H	8D	256	60	302	362	32
	LBD31031910W32H	10D	319	60	368	428	32
	LBD31031912W32H	12D	383	60	432	492	32

СВЁРЛА СО СМЕННЫМИ ГОЛОВКАМИ С ЦИЛИНДРИЧЕСКОЙ НОЖКОЙ. Хвостовик ISO 9766

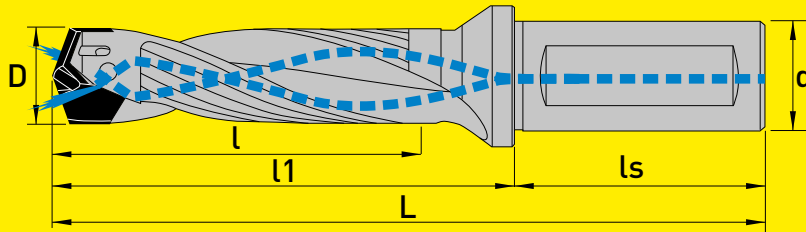

ОКОНЧАНИЕ ТАБЛИЦЫ

Д Диапазон сверления	Артикул	Глубина сверления	l мм	ls мм	l1 мм	L мм	d мм
32.0~32.99	LBD32032903W32H	3D	99	60	146	206	32
	LBD32032905W32H	5D	165	60	212	272	32
	LBD32032908W32H	8D	264	60	311	371	32
	LBD32032910W32H	10D	329	60	379	439	32
	LBD32032912W32H	12D	395	60	445	505	32
33.0~33.99	LBD33033903W32H	3D	102	60	151	211	32
	LBD33033905W32H	5D	170	60	219	279	32
	LBD33033908W32H	8D	272	60	321	381	32
	LBD33033910W32H	10D	339	60	391	451	32
	LBD33033912W32H	12D	407	60	459	519	32
34.0~34.99	LBD34034903W40H	3D	105	70	156	226	40
	LBD34034905W40H	5D	175	70	226	296	40
	LBD34034908W40H	8D	280	70	331	401	40
	LBD34034910W40H	10D	349	70	402	472	40
	LBD34034912W40H	12D	419	70	472	542	40
35.0~35.99	LBD35035903W40H	3D	108	70	160	230	40
	LBD35035905W40H	5D	180	70	232	302	40
	LBD35035908W40H	8D	288	70	340	410	40
	LBD35035910W40H	10D	359	70	414	484	40
	LBD35035912W40H	12D	431	70	486	556	40
36.0~36.99	LBD36036903W40H	3D	111	70	164	234	40
	LBD36036905W40H	5D	185	70	238	308	40
	LBD36036908W40H	8D	296	70	349	419	40
	LBD36036910W40H	10D	369	70	425	495	40
	LBD36036912W40H	12D	443	70	499	569	40
37.0~37.99	LBD37037903W40H	3D	114	70	169	239	40
	LBD37037905W40H	5D	190	70	245	315	40
	LBD37037908W40H	8D	304	70	359	429	40
	LBD37037910W40H	10D	379	70	437	507	40
	LBD37037912W40H	12D	455	70	513	583	40
38.0~38.99	LBD38038903W40H	3D	117	70	173	243	40
	LBD38038905W40H	5D	195	70	251	321	40
	LBD38038908W40H	8D	312	70	368	438	40
	LBD38038910W40H	10D	389	70	448	518	40
	LBD38038912W40H	12D	467	70	526	596	40
39.0~39.99	LBD39039903W40H	3D	123	70	182	252	40
	LBD39039905W40H	5D	205	70	264	334	40
	LBD39039908W40H	8D	328	70	387	457	40
	LBD39039910W40H	10D	400	70	471	541	40
	LBD39039912W40H	12D	480	70	553	623	40

НОВЫЙ ТИП ГОЛОВОК С САМОЦЕНТРИРУЮЩЕЙ ГЕОМЕТРИЕЙ ВЕРШИНЫ «CV»

ГЕОМЕТРИЯ РЕЖУЩЕЙ КРОМКИ

Усиленная режущая кромка в сочетании с оптимизированным передним углом обеспечивает низкие усилия резания и демонстрирует хорошую устойчивость к сколам.

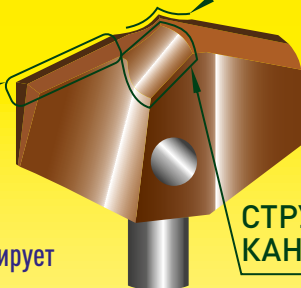

ЦЕНТРИРУЮЩАЯ ВЕРШИНА ГОЛОВКИ

Инновационная конструкция вершины головки гарантирует высокую стабильность сверления и точность получаемых отверстий.

СТРУЖКОРАЗДЕЛИТЕЛЬНАЯ КАНАВКА

Оптимизированная геометрия стружкоразделительных канавок в сочетании с их полированной поверхностью обеспечивает низкое сопротивление эвакуации стружки и высокую скорость ее эвакуации.

ТИП	Виды головок		Материал	
НУ			ASP2015	Прецизионное позиционирование головки по трем плоскостям обеспечивает высокую точность отверстия IT9-IT10 и стабильность процесса сверления. Универсальная режущая геометрия тип U предназначена для обработки широкого спектра материалов, прежде всего сталей с пределом кратковременной прочности на разрыв 500-1100 МПа и обеспечивает низкие усилия резания. Материал головки — высокопроизводительная порошковая быстрорежущая сталь ASP2015. Высокотехнологичное износостойкое покрытие Legend-nS обеспечивает высокую износостойкость и производительность.
НР			ASP2015	Прецизионное позиционирование головки по трем плоскостям обеспечивает высокую точность отверстия IT9-IT10 и стабильность процесса сверления. Режущая геометрия тип Р предназначена для обработки низкоуглеродистых и легкообрабатываемых сталей с пределом кратковременной прочности на разрыв до 500 МПа. Возможна обработка чугунов. Оптимизированная геометрия вершины CV специально предназначена для обработки вязких материалов. Материал головки — высокопроизводительная порошковая быстрорежущая сталь ASP2015. Высокотехнологичное износостойкое покрытие Legend-nS обеспечивает высокую износостойкость и производительность.
СУ			VHM	Прецизионное позиционирование головки по трем плоскостям обеспечивает высокую точность отверстия IT9-IT10 и стабильность процесса сверления. Универсальная режущая геометрия тип U предназначена для обработки широкого спектра материалов, прежде всего сталей с пределом кратковременной прочности на разрыв 500-1100 МПа и обеспечивает низкие усилия резания. Материал головки — высокопроизводительный мелкозернистый твердый сплав. Высокотехнологичное износостойкое покрытие Legend-nT обеспечивает высокую износостойкость и производительность.
СП			VHM	Прецизионное позиционирование головки по трем плоскостям обеспечивает высокую точность отверстия IT9-IT10 и стабильность процесса сверления. Режущая геометрия тип Р предназначена для обработки низкоуглеродистых и легкообрабатываемых сталей с пределом кратковременной прочности на разрыв до 500 МПа. Возможна обработка чугунов. Оптимизированная геометрия вершины CV специально предназначена для обработки вязких материалов. Материал головки — высокопроизводительный мелкозернистый твердый сплав. Высокотехнологичное износостойкое покрытие Legend-nS обеспечивает высокую износостойкость и производительность.
СМ			VHM	Прецизионное позиционирование головки по трем плоскостям обеспечивает высокую точность отверстия IT9-IT10 и стабильность процесса сверления. Режущая геометрия тип М оптимизирована для обработки нержавеющей сталей. Возможна обработка жаропрочных сплавов, а так же материалов групп Р, К и N по ISO. Оптимизированная геометрия вершины CV специально предназначена для обработки вязких материалов. Материал головки — высокопроизводительный мелкозернистый твердый сплав. Высокотехнологичное износостойкое покрытие Legend-nT обеспечивает высокую износостойкость и производительность.
СК			VHM	Прецизионное позиционирование головки по трем плоскостям обеспечивает высокую точность отверстия IT9-IT10 и стабильность процесса сверления. Режущая геометрия тип К оптимизирована для обработки чугунов. Возможна обработка материалов групп N по ISO. Материал головки — высокопроизводительный мелкозернистый твердый сплав. Высокотехнологичное износостойкое покрытие Legend-nT обеспечивает высокую износостойкость и производительность.
СН			VHM	Прецизионное позиционирование головки по трем плоскостям обеспечивает высокую точность отверстия IT9-IT10 и стабильность процесса сверления. Режущая геометрия тип N оптимизирована для обработки материалов групп N по ISO. Материал головки — высокопроизводительный мелкозернистый твердый сплав. Оптимизированное высокотехнологичное покрытие DLC обеспечивает высокую скорость обработки и эффективно предотвращает налипание на режущей кромке.

P1	Легкообрабатываемые автоматные стали
P2	Конструкционные стали
P3	Легированные стали
P4	Термообработанные стали
P5	Инструментальные стали
M	Нержавеющие стали
K1	Серые чугуны
K2	Чугуны с шаровидным графитом
K3	Ковкие чугуны
N1	Алюминиевые сплавы с содержанием Si до 12%
N2	Алюминиевые сплавы с содержанием Si более 12%
N3	Медные сплавы
N4	Неметаллические материалы
S1	Жаропрочные сплавы на основе никеля/суперсплавы
S2	Титановые сплавы
H	Закаленные стали



ВИДЫ ГОЛОВОК														
ТИП	НУ	НР	СУ	СП	СМ	СК	СН							
МАТЕРИАЛ	ASP2015	ASP2015	VHM	VHM	VHM	VHM	VHM	VHM						
ПОКРЫТИЕ	Legend-nS	Legend-nS	Legend-nT	Legend-nS	Legend-nT	Legend-nT	Legend-nT	DLC						
Д мм	Л мм	Артикул	Л мм	Артикул	Л мм	Артикул	Л мм	Артикул	Л мм	Артикул				
10.00	1.8	LBHU-1000	1.8	LBHP-1000	1.8	LBCU-1000	1.8	LBCP-1000	1.8	LBCM-1000	2.2	LBCK-1000	1.8	LBCN-1000
10.10	1.8	LBHU-1010	1.8	LBHP-1010	1.8	LBCU-1010	1.8	LBCP-1010	1.8	LBCM-1010	2.2	LBCK-1010	1.8	LBCN-1010
10.20	1.9	LBHU-1020	1.8	LBHP-1020	1.9	LBCU-1020	1.8	LBCP-1020	1.8	LBCM-1020	2.2	LBCK-1020	1.9	LBCN-1020
10.30	1.9	LBHU-1030	1.8	LBHP-1030	1.9	LBCU-1030	1.8	LBCP-1030	1.8	LBCM-1030	2.2	LBCK-1030	1.9	LBCN-1030
10.40	1.9	LBHU-1040	1.8	LBHP-1040	1.9	LBCU-1040	1.8	LBCP-1040	1.8	LBCM-1040	2.3	LBCK-1040	1.9	LBCN-1040
10.50	1.9	LBHU-1050	1.9	LBHP-1050	1.9	LBCU-1050	1.9	LBCP-1050	1.9	LBCM-1050	2.3	LBCK-1050	1.9	LBCN-1050
10.60	1.9	LBHU-1060	1.9	LBHP-1060	1.9	LBCU-1060	1.9	LBCP-1060	1.9	LBCM-1060	2.3	LBCK-1060	1.9	LBCN-1060
10.70	1.9	LBHU-1070	1.9	LBHP-1070	1.9	LBCU-1070	1.9	LBCP-1070	1.9	LBCM-1070	2.3	LBCK-1070	1.9	LBCN-1070
10.80	2.0	LBHU-1080	1.9	LBHP-1080	2.0	LBCU-1080	1.9	LBCP-1080	1.9	LBCM-1080	2.4	LBCK-1080	2.0	LBCN-1080
10.90	2.0	LBHU-1090	1.9	LBHP-1090	2.0	LBCU-1090	1.9	LBCP-1090	1.9	LBCM-1090	2.4	LBCK-1090	2.0	LBCN-1090
11.00	2.0	LBHU-1100	2.0	LBHP-1100	2.0	LBCU-1100	2.0	LBCP-1100	2.0	LBCM-1100	2.4	LBCK-1100	2.0	LBCN-1100
11.10	2.0	LBHU-1110	2.0	LBHP-1110	2.0	LBCU-1110	2.0	LBCP-1110	2.0	LBCM-1110	2.4	LBCK-1110	2.0	LBCN-1110
11.20	2.0	LBHU-1120	2.0	LBHP-1120	2.0	LBCU-1120	2.0	LBCP-1120	2.0	LBCM-1120	2.4	LBCK-1120	2.0	LBCN-1120
11.30	2.1	LBHU-1130	2.0	LBHP-1130	2.1	LBCU-1130	2.0	LBCP-1130	2.0	LBCM-1130	2.5	LBCK-1130	2.1	LBCN-1130
11.40	2.1	LBHU-1140	2.0	LBHP-1140	2.1	LBCU-1140	2.0	LBCP-1140	2.0	LBCM-1140	2.5	LBCK-1140	2.1	LBCN-1140
11.50	2.1	LBHU-1150	2.0	LBHP-1150	2.1	LBCU-1150	2.0	LBCP-1150	2.0	LBCM-1150	2.5	LBCK-1150	2.1	LBCN-1150
11.60	2.1	LBHU-1160	2.1	LBHP-1160	2.1	LBCU-1160	2.1	LBCP-1160	2.1	LBCM-1160	2.5	LBCK-1160	2.1	LBCN-1160
11.70	2.1	LBHU-1170	2.1	LBHP-1170	2.1	LBCU-1170	2.1	LBCP-1170	2.1	LBCM-1170	2.6	LBCK-1170	2.1	LBCN-1170
11.80	2.1	LBHU-1180	2.1	LBHP-1180	2.1	LBCU-1180	2.1	LBCP-1180	2.1	LBCM-1180	2.6	LBCK-1180	2.1	LBCN-1180
11.90	2.2	LBHU-1190	2.1	LBHP-1190	2.2	LBCU-1190	2.1	LBCP-1190	2.1	LBCM-1190	2.6	LBCK-1190	2.2	LBCN-1190
12.00	2.2	LBHU-1200	2.1	LBHP-1200	2.2	LBCU-1200	2.1	LBCP-1200	2.1	LBCM-1200	2.6	LBCK-1200	2.2	LBCN-1200
12.10	2.2	LBHU-1210	2.1	LBHP-1210	2.2	LBCU-1210	2.1	LBCP-1210	2.1	LBCM-1210	2.6	LBCK-1210	2.2	LBCN-1210
12.20	2.2	LBHU-1220	2.2	LBHP-1220	2.2	LBCU-1220	2.2	LBCP-1220	2.2	LBCM-1220	2.7	LBCK-1220	2.2	LBCN-1220
12.30	2.2	LBHU-1230	2.2	LBHP-1230	2.2	LBCU-1230	2.2	LBCP-1230	2.2	LBCM-1230	2.7	LBCK-1230	2.2	LBCN-1230
12.40	2.3	LBHU-1240	2.2	LBHP-1240	2.3	LBCU-1240	2.2	LBCP-1240	2.2	LBCM-1240	2.7	LBCK-1240	2.3	LBCN-1240
12.50	2.3	LBHU-1250	2.2	LBHP-1250	2.3	LBCU-1250	2.2	LBCP-1250	2.2	LBCM-1250	2.7	LBCK-1250	2.3	LBCN-1250
12.60	2.3	LBHU-1260	2.2	LBHP-1260	2.3	LBCU-1260	2.2	LBCP-1260	2.2	LBCM-1260	2.7	LBCK-1260	2.3	LBCN-1260
12.70	2.3	LBHU-1270	2.3	LBHP-1270	2.3	LBCU-1270	2.3	LBCP-1270	2.3	LBCM-1270	2.8	LBCK-1270	2.3	LBCN-1270
12.80	2.3	LBHU-1280	2.3	LBHP-1280	2.3	LBCU-1280	2.3	LBCP-1280	2.3	LBCM-1280	2.8	LBCK-1280	2.3	LBCN-1280
12.90	2.3	LBHU-1290	2.3	LBHP-1290	2.3	LBCU-1290	2.3	LBCP-1290	2.3	LBCM-1290	2.8	LBCK-1290	2.3	LBCN-1290
13.00	2.4	LBHU-1300	2.3	LBHP-1300	2.4	LBCU-1300	2.3	LBCP-1300	2.3	LBCM-1300	2.8	LBCK-1300	2.4	LBCN-1300
13.10	2.4	LBHU-1310	2.3	LBHP-1310	2.4	LBCU-1310	2.3	LBCP-1310	2.3	LBCM-1310	2.9	LBCK-1310	2.4	LBCN-1310
13.20	2.4	LBHU-1320	2.3	LBHP-1320	2.4	LBCU-1320	2.3	LBCP-1320	2.3	LBCM-1320	2.9	LBCK-1320	2.4	LBCN-1320
13.30	2.4	LBHU-1330	2.4	LBHP-1330	2.4	LBCU-1330	2.4	LBCP-1330	2.4	LBCM-1330	2.9	LBCK-1330	2.4	LBCN-1330
13.40	2.4	LBHU-1340	2.4	LBHP-1340	2.4	LBCU-1340	2.4	LBCP-1340	2.4	LBCM-1340	2.9	LBCK-1340	2.4	LBCN-1340
13.50	2.5	LBHU-1350	2.4	LBHP-1350	2.5	LBCU-1350	2.4	LBCP-1350	2.4	LBCM-1350	2.9	LBCK-1350	2.5	LBCN-1350
13.60	2.5	LBHU-1360	2.4	LBHP-1360	2.5	LBCU-1360	2.4	LBCP-1360	2.4	LBCM-1360	3.0	LBCK-1360	2.5	LBCN-1360
13.70	2.5	LBHU-1370	2.4	LBHP-1370	2.5	LBCU-1370	2.4	LBCP-1370	2.4	LBCM-1370	3.0	LBCK-1370	2.5	LBCN-1370
13.80	2.5	LBHU-1380	2.4	LBHP-1380	2.5	LBCU-1380	2.4	LBCP-1380	2.4	LBCM-1380	3.0	LBCK-1380	2.5	LBCN-1380
13.90	2.5	LBHU-1390	2.5	LBHP-1390	2.5	LBCU-1390	2.5	LBCP-1390	2.5	LBCM-1390	3.0	LBCK-1390	2.5	LBCN-1390
P1	<500N	☆		★		☆		★		☆				
P2	<750N	★				★								
P3	<1400N	★				★				☆				
P4	<1400N	☆				☆								
P5	<1200N	★				★				☆				
M	<900N	☆				☆				★				
K1	<750N	☆		☆		☆		☆		☆		★		
K2	≤900N	☆		☆		☆		☆		☆		★		
K3	<1100N	☆		☆		☆		☆		☆		★		
N1	Si<12%	☆				☆				☆		☆		★
N2	Si>12%	☆				☆				☆		☆		★
N3	<750N	☆				☆				☆		☆		★
N4		☆				☆				☆		☆		★
S1	<1100N	☆				☆								
S2	<1100N	☆				☆								
H	<1600N					☆								



СИСТЕМА СВЕРЛЕНИЯ «LightBreeze». ГОЛОВКИ

ПРОДОЛЖЕНИЕ ТАБЛИЦЫ

ВИДЫ ГОЛОВОК														
	HU		HP		CU		CP		CM		CK		CN	
ТИП	ASP2015		ASP2015		VHM		VHM		VHM		VHM		VHM	
МАТЕРИАЛ	ASP2015		ASP2015		VHM		VHM		VHM		VHM		VHM	
ПОКРЫТИЕ	Legend-nS		Legend-nS		Legend-nT		Legend-nS		Legend-nT		Legend-nT		DLC	
D мм	L мм	Артикул	L мм	Артикул	L мм	Артикул	L мм	Артикул	L мм	Артикул	L мм	Артикул	L мм	Артикул
14.00	2.5	LBHU-1400	2.5	LBHP-1400	2.5	LBCU-1400	2.5	LBCP-1400	2.5	LBCM-1400	3.1	LBCK-1400	2.5	LBCN-1400
14.10	2.6	LBHU-1410	2.5	LBHP-1410	2.6	LBCU-1410	2.5	LBCP-1410	2.5	LBCM-1410	3.1	LBCK-1410	2.6	LBCN-1410
14.20	2.6	LBHU-1420	2.5	LBHP-1420	2.6	LBCU-1420	2.5	LBCP-1420	2.5	LBCM-1420	3.1	LBCK-1420	2.6	LBCN-1420
14.30	2.6	LBHU-1430	2.5	LBHP-1430	2.6	LBCU-1430	2.5	LBCP-1430	2.5	LBCM-1430	3.1	LBCK-1430	2.6	LBCN-1430
14.40	2.6	LBHU-1440	2.6	LBHP-1440	2.6	LBCU-1440	2.6	LBCP-1440	2.6	LBCM-1440	3.1	LBCK-1440	2.6	LBCN-1440
14.50	2.6	LBHU-1450	2.6	LBHP-1450	2.6	LBCU-1450	2.6	LBCP-1450	2.6	LBCM-1450	3.2	LBCK-1450	2.6	LBCN-1450
14.60	2.7	LBHU-1460	2.6	LBHP-1460	2.7	LBCU-1460	2.6	LBCP-1460	2.6	LBCM-1460	3.2	LBCK-1460	2.7	LBCN-1460
14.70	2.7	LBHU-1470	2.6	LBHP-1470	2.7	LBCU-1470	2.6	LBCP-1470	2.6	LBCM-1470	3.2	LBCK-1470	2.7	LBCN-1470
14.80	2.7	LBHU-1480	2.6	LBHP-1480	2.7	LBCU-1480	2.6	LBCP-1480	2.6	LBCM-1480	3.2	LBCK-1480	2.7	LBCN-1480
14.90	2.7	LBHU-1490	2.6	LBHP-1490	2.7	LBCU-1490	2.6	LBCP-1490	2.6	LBCM-1490	3.2	LBCK-1490	2.7	LBCN-1490
15.00	2.7	LBHU-1500	2.7	LBHP-1500	2.7	LBCU-1500	2.7	LBCP-1500	2.7	LBCM-1500	3.3	LBCK-1500	2.7	LBCN-1500
15.10	2.7	LBHU-1510	2.7	LBHP-1510	2.7	LBCU-1510	2.7	LBCP-1510	2.7	LBCM-1510	3.3	LBCK-1510	2.7	LBCN-1510
15.20	2.8	LBHU-1520	2.7	LBHP-1520	2.8	LBCU-1520	2.7	LBCP-1520	2.7	LBCM-1520	3.3	LBCK-1520	2.8	LBCN-1520
15.30	2.8	LBHU-1530	2.7	LBHP-1530	2.8	LBCU-1530	2.7	LBCP-1530	2.7	LBCM-1530	3.3	LBCK-1530	2.8	LBCN-1530
15.40	2.8	LBHU-1540	2.7	LBHP-1540	2.8	LBCU-1540	2.7	LBCP-1540	2.7	LBCM-1540	3.4	LBCK-1540	2.8	LBCN-1540
15.50	2.8	LBHU-1550	2.7	LBHP-1550	2.8	LBCU-1550	2.7	LBCP-1550	2.7	LBCM-1550	3.4	LBCK-1550	2.8	LBCN-1550
15.60	2.8	LBHU-1560	2.8	LBHP-1560	2.8	LBCU-1560	2.8	LBCP-1560	2.8	LBCM-1560	3.4	LBCK-1560	2.8	LBCN-1560
15.70	2.9	LBHU-1570	2.8	LBHP-1570	2.9	LBCU-1570	2.8	LBCP-1570	2.8	LBCM-1570	3.4	LBCK-1570	2.9	LBCN-1570
15.80	2.9	LBHU-1580	2.8	LBHP-1580	2.9	LBCU-1580	2.8	LBCP-1580	2.8	LBCM-1580	3.4	LBCK-1580	2.9	LBCN-1580
15.90	2.9	LBHU-1590	2.8	LBHP-1590	2.9	LBCU-1590	2.8	LBCP-1590	2.8	LBCM-1590	3.5	LBCK-1590	2.9	LBCN-1590
16.00	2.9	LBHU-1600	2.8	LBHP-1600	2.9	LBCU-1600	2.8	LBCP-1600	2.8	LBCM-1600	3.5	LBCK-1600	2.9	LBCN-1600
16.10	2.9	LBHU-1610	2.9	LBHP-1610	2.9	LBCU-1610	2.9	LBCP-1610	2.9	LBCM-1610	3.5	LBCK-1610	2.9	LBCN-1610
16.20	2.9	LBHU-1620	2.9	LBHP-1620	2.9	LBCU-1620	2.9	LBCP-1620	2.9	LBCM-1620	3.5	LBCK-1620	2.9	LBCN-1620
16.30	3.0	LBHU-1630	2.9	LBHP-1630	3.0	LBCU-1630	2.9	LBCP-1630	2.9	LBCM-1630	3.6	LBCK-1630	3.0	LBCN-1630
16.40	3.0	LBHU-1640	2.9	LBHP-1640	3.0	LBCU-1640	2.9	LBCP-1640	2.9	LBCM-1640	3.6	LBCK-1640	3.0	LBCN-1640
16.50	3.0	LBHU-1650	2.9	LBHP-1650	3.0	LBCU-1650	2.9	LBCP-1650	2.9	LBCM-1650	3.6	LBCK-1650	3.0	LBCN-1650
16.60	3.0	LBHU-1660	2.9	LBHP-1660	3.0	LBCU-1660	2.9	LBCP-1660	2.9	LBCM-1660	3.6	LBCK-1660	3.0	LBCN-1660
16.70	3.0	LBHU-1670	3.0	LBHP-1670	3.0	LBCU-1670	3.0	LBCP-1670	3.0	LBCM-1670	3.6	LBCK-1670	3.0	LBCN-1670
16.80	3.1	LBHU-1680	3.0	LBHP-1680	3.1	LBCU-1680	3.0	LBCP-1680	3.0	LBCM-1680	3.7	LBCK-1680	3.1	LBCN-1680
16.90	3.1	LBHU-1690	3.0	LBHP-1690	3.1	LBCU-1690	3.0	LBCP-1690	3.0	LBCM-1690	3.7	LBCK-1690	3.1	LBCN-1690
17.00	3.1	LBHU-1700	3.0	LBHP-1700	3.1	LBCU-1700	3.0	LBCP-1700	3.0	LBCM-1700	3.7	LBCK-1700	3.1	LBCN-1700
17.10	3.1	LBHU-1710	3.0	LBHP-1710	3.1	LBCU-1710	3.0	LBCP-1710	3.0	LBCM-1710	3.7	LBCK-1710	3.1	LBCN-1710
17.20	3.1	LBHU-1720	3.0	LBHP-1720	3.1	LBCU-1720	3.0	LBCP-1720	3.0	LBCM-1720	3.7	LBCK-1720	3.1	LBCN-1720
17.30	3.1	LBHU-1730	3.1	LBHP-1730	3.1	LBCU-1730	3.1	LBCP-1730	3.1	LBCM-1730	3.8	LBCK-1730	3.1	LBCN-1730
17.40	3.2	LBHU-1740	3.1	LBHP-1740	3.2	LBCU-1740	3.1	LBCP-1740	3.1	LBCM-1740	3.8	LBCK-1740	3.2	LBCN-1740
17.50	3.2	LBHU-1750	3.1	LBHP-1750	3.2	LBCU-1750	3.1	LBCP-1750	3.1	LBCM-1750	3.8	LBCK-1750	3.2	LBCN-1750
17.60	3.2	LBHU-1760	3.1	LBHP-1760	3.2	LBCU-1760	3.1	LBCP-1760	3.1	LBCM-1760	3.8	LBCK-1760	3.2	LBCN-1760
17.70	3.2	LBHU-1770	3.1	LBHP-1770	3.2	LBCU-1770	3.1	LBCP-1770	3.1	LBCM-1770	3.9	LBCK-1770	3.2	LBCN-1770
17.80	3.2	LBHU-1780	3.2	LBHP-1780	3.2	LBCU-1780	3.2	LBCP-1780	3.2	LBCM-1780	3.9	LBCK-1780	3.2	LBCN-1780
17.90	3.3	LBHU-1790	3.2	LBHP-1790	3.3	LBCU-1790	3.2	LBCP-1790	3.2	LBCM-1790	3.9	LBCK-1790	3.3	LBCN-1790
P1 <500N		☆		★		☆		★		☆				
P2 <750N		★				★				★				
P3 <1400N		★				★				★				
P4 <1400N		☆				☆				☆				
P5 <1200N		★				★				★				
M <900N		☆				☆				★				
K1 <750N		☆		☆		☆		☆		☆		★		
K2 ≤900N		☆		☆		☆		☆		☆		★		
K3 <1100N		☆		☆		☆		☆		☆		★		
N1 Si<12%		☆				☆				☆		☆		★
N2 Si>12%		☆				☆				☆		☆		★
N3 <750N		☆				☆				☆		☆		★
N4		☆				☆				☆		☆		★
S1 <1100N		☆				☆				☆				
S2 <1100N		☆				☆				☆				
H <1600N						☆								



ПРОДОЛЖЕНИЕ ТАБЛИЦЫ

ВИДЫ ГОЛОВОК														
ТИП	НУ	НР	СУ	СП	СМ	СК	СН							
МАТЕРИАЛ	ASP2015	ASP2015	VHM	VHM	VHM	VHM	VHM	VHM						
ПОКРЫТИЕ	Legend-nS	Legend-nS	Legend-nT	Legend-nS	Legend-nT	Legend-nT	Legend-nT	DLC						
Д мм	l мм	Артикул	l мм	Артикул	l мм	Артикул	l мм	Артикул	l мм	Артикул				
18.00	3.3	LBHU-1800	3.2	LBHP-1800	3.3	LBCU-1800	3.2	LBCP-1800	3.2	LBCM-1800	3.9	LBCK-1800	3.3	LBCN-1800
18.10	3.3	LBHU-1810	3.2	LBHP-1810	3.3	LBCU-1810	3.2	LBCP-1810	3.2	LBCM-1810	3.9	LBCK-1810	3.3	LBCN-1810
18.20	3.3	LBHU-1820	3.2	LBHP-1820	3.3	LBCU-1820	3.2	LBCP-1820	3.2	LBCM-1820	4.0	LBCK-1820	3.3	LBCN-1820
18.30	3.3	LBHU-1830	3.2	LBHP-1830	3.3	LBCU-1830	3.2	LBCP-1830	3.2	LBCM-1830	4.0	LBCK-1830	3.3	LBCN-1830
18.40	3.3	LBHU-1840	3.3	LBHP-1840	3.3	LBCU-1840	3.3	LBCP-1840	3.3	LBCM-1840	4.0	LBCK-1840	3.3	LBCN-1840
18.50	3.4	LBHU-1850	3.3	LBHP-1850	3.4	LBCU-1850	3.3	LBCP-1850	3.3	LBCM-1850	4.0	LBCK-1850	3.4	LBCN-1850
18.60	3.4	LBHU-1860	3.3	LBHP-1860	3.4	LBCU-1860	3.3	LBCP-1860	3.3	LBCM-1860	4.1	LBCK-1860	3.4	LBCN-1860
18.70	3.4	LBHU-1870	3.3	LBHP-1870	3.4	LBCU-1870	3.3	LBCP-1870	3.3	LBCM-1870	4.1	LBCK-1870	3.4	LBCN-1870
18.80	3.4	LBHU-1880	3.3	LBHP-1880	3.4	LBCU-1880	3.3	LBCP-1880	3.3	LBCM-1880	4.1	LBCK-1880	3.4	LBCN-1880
18.90	3.4	LBHU-1890	3.4	LBHP-1890	3.4	LBCU-1890	3.4	LBCP-1890	3.4	LBCM-1890	4.1	LBCK-1890	3.4	LBCN-1890
19.00	3.5	LBHU-1900	3.4	LBHP-1900	3.5	LBCU-1900	3.4	LBCP-1900	3.4	LBCM-1900	4.1	LBCK-1900	3.5	LBCN-1900
19.10	3.5	LBHU-1910	3.4	LBHP-1910	3.5	LBCU-1910	3.4	LBCP-1910	3.4	LBCM-1910	4.2	LBCK-1910	3.5	LBCN-1910
19.20	3.5	LBHU-1920	3.4	LBHP-1920	3.5	LBCU-1920	3.4	LBCP-1920	3.4	LBCM-1920	4.2	LBCK-1920	3.5	LBCN-1920
19.30	3.5	LBHU-1930	3.4	LBHP-1930	3.5	LBCU-1930	3.4	LBCP-1930	3.4	LBCM-1930	4.2	LBCK-1930	3.5	LBCN-1930
19.40	3.5	LBHU-1940	3.4	LBHP-1940	3.5	LBCU-1940	3.4	LBCP-1940	3.4	LBCM-1940	4.2	LBCK-1940	3.5	LBCN-1940
19.50	3.5	LBHU-1950	3.5	LBHP-1950	3.5	LBCU-1950	3.5	LBCP-1950	3.5	LBCM-1950	4.3	LBCK-1950	3.5	LBCN-1950
19.60	3.6	LBHU-1960	3.5	LBHP-1960	3.6	LBCU-1960	3.5	LBCP-1960	3.5	LBCM-1960	4.3	LBCK-1960	3.6	LBCN-1960
19.70	3.6	LBHU-1970	3.5	LBHP-1970	3.6	LBCU-1970	3.5	LBCP-1970	3.5	LBCM-1970	4.3	LBCK-1970	3.6	LBCN-1970
19.80	3.6	LBHU-1980	3.5	LBHP-1980	3.6	LBCU-1980	3.5	LBCP-1980	3.5	LBCM-1980	4.3	LBCK-1980	3.6	LBCN-1980
19.90	3.6	LBHU-1990	3.5	LBHP-1990	3.6	LBCU-1990	3.5	LBCP-1990	3.5	LBCM-1990	4.3	LBCK-1990	3.6	LBCN-1990
20.00	3.6	LBHU-2000	3.5	LBHP-2000	3.6	LBCU-2000	3.5	LBCP-2000	3.5	LBCM-2000	4.4	LBCK-2000	3.6	LBCN-2000
20.10	3.7	LBHU-2010	3.6	LBHP-2010	3.7	LBCU-2010	3.6	LBCP-2010	3.6	LBCM-2010	4.4	LBCK-2010	3.7	LBCN-2010
20.20	3.7	LBHU-2020	3.6	LBHP-2020	3.7	LBCU-2020	3.6	LBCP-2020	3.6	LBCM-2020	4.4	LBCK-2020	3.7	LBCN-2020
20.30	3.7	LBHU-2030	3.6	LBHP-2030	3.7	LBCU-2030	3.6	LBCP-2030	3.6	LBCM-2030	4.4	LBCK-2030	3.7	LBCN-2030
20.40	3.7	LBHU-2040	3.6	LBHP-2040	3.7	LBCU-2040	3.6	LBCP-2040	3.6	LBCM-2040	4.4	LBCK-2040	3.7	LBCN-2040
20.50	3.7	LBHU-2050	3.6	LBHP-2050	3.7	LBCU-2050	3.6	LBCP-2050	3.6	LBCM-2050	4.5	LBCK-2050	3.7	LBCN-2050
20.60	3.7	LBHU-2060	3.7	LBHP-2060	3.7	LBCU-2060	3.7	LBCP-2060	3.7	LBCM-2060	4.5	LBCK-2060	3.7	LBCN-2060
20.70	3.8	LBHU-2070	3.7	LBHP-2070	3.8	LBCU-2070	3.7	LBCP-2070	3.7	LBCM-2070	4.5	LBCK-2070	3.8	LBCN-2070
20.80	3.8	LBHU-2080	3.7	LBHP-2080	3.8	LBCU-2080	3.7	LBCP-2080	3.7	LBCM-2080	4.5	LBCK-2080	3.8	LBCN-2080
20.90	3.8	LBHU-2090	3.7	LBHP-2090	3.8	LBCU-2090	3.7	LBCP-2090	3.7	LBCM-2090	4.6	LBCK-2090	3.8	LBCN-2090
21.00	3.8	LBHU-2100	3.7	LBHP-2100	3.8	LBCU-2100	3.7	LBCP-2100	3.7	LBCM-2100	4.6	LBCK-2100	3.8	LBCN-2100
21.10	3.8	LBHU-2110	3.7	LBHP-2110	3.8	LBCU-2110	3.7	LBCP-2110	3.7	LBCM-2110	4.6	LBCK-2110	3.8	LBCN-2110
21.20	3.9	LBHU-2120	3.8	LBHP-2120	3.9	LBCU-2120	3.8	LBCP-2120	3.8	LBCM-2120	4.6	LBCK-2120	3.9	LBCN-2120
21.30	3.9	LBHU-2130	3.8	LBHP-2130	3.9	LBCU-2130	3.8	LBCP-2130	3.8	LBCM-2130	4.6	LBCK-2130	3.9	LBCN-2130
21.40	3.9	LBHU-2140	3.8	LBHP-2140	3.9	LBCU-2140	3.8	LBCP-2140	3.8	LBCM-2140	4.7	LBCK-2140	3.9	LBCN-2140
21.50	3.9	LBHU-2150	3.8	LBHP-2150	3.9	LBCU-2150	3.8	LBCP-2150	3.8	LBCM-2150	4.7	LBCK-2150	3.9	LBCN-2150
21.60	3.9	LBHU-2160	3.8	LBHP-2160	3.9	LBCU-2160	3.8	LBCP-2160	3.8	LBCM-2160	4.7	LBCK-2160	3.9	LBCN-2160
21.70	3.9	LBHU-2170	3.8	LBHP-2170	3.9	LBCU-2170	3.8	LBCP-2170	3.8	LBCM-2170	4.7	LBCK-2170	3.9	LBCN-2170
21.80	4.0	LBHU-2180	3.9	LBHP-2180	4.0	LBCU-2180	3.9	LBCP-2180	3.9	LBCM-2180	4.8	LBCK-2180	4.0	LBCN-2180
21.90	4.0	LBHU-2190	3.9	LBHP-2190	4.0	LBCU-2190	3.9	LBCP-2190	3.9	LBCM-2190	4.8	LBCK-2190	4.0	LBCN-2190
P1	<500N	☆		★		☆		★						
P2	<750N	★				★				☆				
P3	<1400N	★				★				☆				
P4	<1400N	☆				☆								
P5	<1200N	★				★				☆				
M	<900N	☆				☆				★				
K1	<750N	☆		☆		☆		☆		☆		★		
K2	≤900N	☆		☆		☆		☆		☆		★		
K3	<1100N	☆		☆		☆		☆		☆		★		
N1	Si<12%	☆				☆				☆				★
N2	Si>12%	☆				☆				☆				★
N3	<750N	☆				☆				☆				★
N4		☆				☆				☆				★
S1	<1100N	☆				☆								
S2	<1100N	☆				☆								
H	<1600N					☆								



СИСТЕМА СВЕРЛЕНИЯ «LightBreeze». ГОЛОВКИ

ПРОДОЛЖЕНИЕ ТАБЛИЦЫ

ВИДЫ ГОЛОВОК														
	HU		HP		CU		CP		CM		CK		CN	
ТИП	ASP2015		ASP2015		VHM		VHM		VHM		VHM		VHM	
МАТЕРИАЛ	ASP2015		ASP2015		VHM		VHM		VHM		VHM		VHM	
ПОКРЫТИЕ	Legend-nS		Legend-nS		Legend-nT		Legend-nS		Legend-nT		Legend-nT		DLC	
Д мм	l мм	Артикул	l мм	Артикул	l мм	Артикул	l мм	Артикул	l мм	Артикул	l мм	Артикул	l мм	Артикул
22.00	4.0	LBHU-2200	3.9	LBHP-2200	4.0	LBCU-2200	3.9	LBCP-2200	3.9	LBCM-2200	4.8	LBCK-2200	4.0	LBCN-2200
22.10	4.0	LBHU-2210	3.9	LBHP-2210	4.0	LBCU-2210	3.9	LBCP-2210	3.9	LBCM-2210	4.8	LBCK-2210	4.0	LBCN-2210
22.20	4.0	LBHU-2220	3.9	LBHP-2220	4.0	LBCU-2220	3.9	LBCP-2220	3.9	LBCM-2220	4.8	LBCK-2220	4.0	LBCN-2220
22.30	4.1	LBHU-2230	4.0	LBHP-2230	4.1	LBCU-2230	4.0	LBCP-2230	4.0	LBCM-2230	4.9	LBCK-2230	4.1	LBCN-2230
22.40	4.1	LBHU-2240	4.0	LBHP-2240	4.1	LBCU-2240	4.0	LBCP-2240	4.0	LBCM-2240	4.9	LBCK-2240	4.1	LBCN-2240
22.50	4.1	LBHU-2250	4.0	LBHP-2250	4.1	LBCU-2250	4.0	LBCP-2250	4.0	LBCM-2250	4.9	LBCK-2250	4.1	LBCN-2250
22.60	4.1	LBHU-2260	4.0	LBHP-2260	4.1	LBCU-2260	4.0	LBCP-2260	4.0	LBCM-2260	4.9	LBCK-2260	4.1	LBCN-2260
22.70	4.1	LBHU-2270	4.0	LBHP-2270	4.1	LBCU-2270	4.0	LBCP-2270	4.0	LBCM-2270	4.9	LBCK-2270	4.1	LBCN-2270
22.80	4.1	LBHU-2280	4.0	LBHP-2280	4.1	LBCU-2280	4.0	LBCP-2280	4.0	LBCM-2280	5.0	LBCK-2280	4.1	LBCN-2280
22.90	4.2	LBHU-2290	4.1	LBHP-2290	4.2	LBCU-2290	4.1	LBCP-2290	4.1	LBCM-2290	5.0	LBCK-2290	4.2	LBCN-2290
23.00	4.2	LBHU-2300	4.1	LBHP-2300	4.2	LBCU-2300	4.1	LBCP-2300	4.1	LBCM-2300	5.0	LBCK-2300	4.2	LBCN-2300
23.10	4.2	LBHU-2310	4.1	LBHP-2310	4.2	LBCU-2310	4.1	LBCP-2310	4.1	LBCM-2310	5.0	LBCK-2310	4.2	LBCN-2310
23.20	4.2	LBHU-2320	4.1	LBHP-2320	4.2	LBCU-2320	4.1	LBCP-2320	4.1	LBCM-2320	5.1	LBCK-2320	4.2	LBCN-2320
23.30	4.2	LBHU-2330	4.1	LBHP-2330	4.2	LBCU-2330	4.1	LBCP-2330	4.1	LBCM-2330	5.1	LBCK-2330	4.2	LBCN-2330
23.40	4.3	LBHU-2340	4.1	LBHP-2340	4.3	LBCU-2340	4.1	LBCP-2340	4.1	LBCM-2340	5.1	LBCK-2340	4.3	LBCN-2340
23.50	4.3	LBHU-2350	4.2	LBHP-2350	4.3	LBCU-2350	4.2	LBCP-2350	4.2	LBCM-2350	5.1	LBCK-2350	4.3	LBCN-2350
23.60	4.3	LBHU-2360	4.2	LBHP-2360	4.3	LBCU-2360	4.2	LBCP-2360	4.2	LBCM-2360	5.1	LBCK-2360	4.3	LBCN-2360
23.70	4.3	LBHU-2370	4.2	LBHP-2370	4.3	LBCU-2370	4.2	LBCP-2370	4.2	LBCM-2370	5.2	LBCK-2370	4.3	LBCN-2370
23.80	4.3	LBHU-2380	4.2	LBHP-2380	4.3	LBCU-2380	4.2	LBCP-2380	4.2	LBCM-2380	5.2	LBCK-2380	4.3	LBCN-2380
23.90	4.3	LBHU-2390	4.2	LBHP-2390	4.3	LBCU-2390	4.2	LBCP-2390	4.2	LBCM-2390	5.2	LBCK-2390	4.3	LBCN-2390
24.00	4.4	LBHU-2400	4.3	LBHP-2400	4.4	LBCU-2400	4.3	LBCP-2400	4.3	LBCM-2400	5.2	LBCK-2400	4.4	LBCN-2400
24.10	4.4	LBHU-2410	4.3	LBHP-2410	4.4	LBCU-2410	4.3	LBCP-2410	4.3	LBCM-2410	5.3	LBCK-2410	4.4	LBCN-2410
24.20	4.4	LBHU-2420	4.3	LBHP-2420	4.4	LBCU-2420	4.3	LBCP-2420	4.3	LBCM-2420	5.3	LBCK-2420	4.4	LBCN-2420
24.30	4.4	LBHU-2430	4.3	LBHP-2430	4.4	LBCU-2430	4.3	LBCP-2430	4.3	LBCM-2430	5.3	LBCK-2430	4.4	LBCN-2430
24.40	4.4	LBHU-2440	4.3	LBHP-2440	4.4	LBCU-2440	4.3	LBCP-2440	4.3	LBCM-2440	5.3	LBCK-2440	4.4	LBCN-2440
24.50	4.5	LBHU-2450	4.3	LBHP-2450	4.5	LBCU-2450	4.3	LBCP-2450	4.3	LBCM-2450	5.3	LBCK-2450	4.5	LBCN-2450
24.60	4.5	LBHU-2460	4.4	LBHP-2460	4.5	LBCU-2460	4.4	LBCP-2460	4.4	LBCM-2460	5.4	LBCK-2460	4.5	LBCN-2460
24.70	4.5	LBHU-2470	4.4	LBHP-2470	4.5	LBCU-2470	4.4	LBCP-2470	4.4	LBCM-2470	5.4	LBCK-2470	4.5	LBCN-2470
24.80	4.5	LBHU-2480	4.4	LBHP-2480	4.5	LBCU-2480	4.4	LBCP-2480	4.4	LBCM-2480	5.4	LBCK-2480	4.5	LBCN-2480
24.90	4.5	LBHU-2490	4.4	LBHP-2490	4.5	LBCU-2490	4.4	LBCP-2490	4.4	LBCM-2490	5.4	LBCK-2490	4.5	LBCN-2490
25.00	4.5	LBHU-2500	4.4	LBHP-2500	4.5	LBCU-2500	4.4	LBCP-2500	4.4	LBCM-2500	5.4	LBCK-2500	4.5	LBCN-2500
25.10	4.6	LBHU-2510	4.5	LBHP-2510	4.6	LBCU-2510	4.5	LBCP-2510	4.5	LBCM-2510	5.5	LBCK-2510	4.6	LBCN-2510
25.20	4.6	LBHU-2520	4.5	LBHP-2520	4.6	LBCU-2520	4.5	LBCP-2520	4.5	LBCM-2520	5.5	LBCK-2520	4.6	LBCN-2520
25.30	4.6	LBHU-2530	4.5	LBHP-2530	4.6	LBCU-2530	4.5	LBCP-2530	4.5	LBCM-2530	5.5	LBCK-2530	4.6	LBCN-2530
25.40	4.6	LBHU-2540	4.5	LBHP-2540	4.6	LBCU-2540	4.5	LBCP-2540	4.5	LBCM-2540	5.5	LBCK-2540	4.6	LBCN-2540
25.50	4.6	LBHU-2550	4.5	LBHP-2550	4.6	LBCU-2550	4.5	LBCP-2550	4.5	LBCM-2550	5.6	LBCK-2550	4.6	LBCN-2550
25.60	4.7	LBHU-2560	4.5	LBHP-2560	4.7	LBCU-2560	4.5	LBCP-2560	4.5	LBCM-2560	5.6	LBCK-2560	4.7	LBCN-2560
25.70	4.7	LBHU-2570	4.6	LBHP-2570	4.7	LBCU-2570	4.6	LBCP-2570	4.6	LBCM-2570	5.6	LBCK-2570	4.7	LBCN-2570
25.80	4.7	LBHU-2580	4.6	LBHP-2580	4.7	LBCU-2580	4.6	LBCP-2580	4.6	LBCM-2580	5.6	LBCK-2580	4.7	LBCN-2580
25.90	4.7	LBHU-2590	4.6	LBHP-2590	4.7	LBCU-2590	4.6	LBCP-2590	4.6	LBCM-2590	5.6	LBCK-2590	4.7	LBCN-2590
P1	<500N	☆	★	☆	☆	★	☆	★	☆	☆	☆	☆	☆	☆
P2	<750N	★	★	★	★	★	★	★	★	★	★	★	★	★
P3	<1400N	★	★	★	★	★	★	★	★	★	★	★	★	★
P4	<1400N	☆	☆	☆	☆	☆	☆	☆	☆	☆	☆	☆	☆	☆
P5	<1200N	★	★	★	★	★	★	★	★	★	★	★	★	★
M	<900N	☆	☆	☆	☆	☆	☆	☆	☆	☆	☆	☆	☆	☆
K1	<750N	☆	☆	☆	☆	☆	☆	☆	☆	☆	☆	☆	☆	☆
K2	≤900N	☆	☆	☆	☆	☆	☆	☆	☆	☆	☆	☆	☆	☆
K3	<1100N	☆	☆	☆	☆	☆	☆	☆	☆	☆	☆	☆	☆	☆
N1	Si<12%	☆	☆	☆	☆	☆	☆	☆	☆	☆	☆	☆	☆	☆
N2	Si>12%	☆	☆	☆	☆	☆	☆	☆	☆	☆	☆	☆	☆	☆
N3	<750N	☆	☆	☆	☆	☆	☆	☆	☆	☆	☆	☆	☆	☆
N4		☆	☆	☆	☆	☆	☆	☆	☆	☆	☆	☆	☆	☆
S1	<1100N	☆	☆	☆	☆	☆	☆	☆	☆	☆	☆	☆	☆	☆
S2	<1100N	☆	☆	☆	☆	☆	☆	☆	☆	☆	☆	☆	☆	☆
H	<1600N	☆	☆	☆	☆	☆	☆	☆	☆	☆	☆	☆	☆	☆



ПРОДОЛЖЕНИЕ ТАБЛИЦЫ

ВИДЫ ГОЛОВОК														
ТИП	НУ	НР	СУ	СП	СМ	СК	СН							
МАТЕРИАЛ	ASP2015	ASP2015	VHM	VHM	VHM	VHM	VHM	VHM						
ПОКРЫТИЕ	Legend-nS	Legend-nS	Legend-nT	Legend-nS	Legend-nT	Legend-nT	Legend-nT	DLC						
Д мм	l мм	Артикул	l мм	Артикул	l мм	Артикул	l мм	Артикул	l мм	Артикул				
26.00	4.7	LBНУ-2600	4.6	LBНР-2600	4.7	LBCУ-2600	4.6	LBCП-2600	4.6	LBCМ-2600	5.7	LBСК-2600	4.7	LBCН-2600
26.10	4.7	LBНУ-2610	4.6	LBНР-2610	4.7	LBCУ-2610	4.6	LBCП-2610	4.6	LBCМ-2610	5.7	LBСК-2610	4.7	LBCН-2610
26.20	4.8	LBНУ-2620	4.6	LBНР-2620	4.8	LBCУ-2620	4.6	LBCП-2620	4.6	LBCМ-2620	5.7	LBСК-2620	4.8	LBCН-2620
26.30	4.8	LBНУ-2630	4.7	LBНР-2630	4.8	LBCУ-2630	4.7	LBCП-2630	4.7	LBCМ-2630	5.7	LBСК-2630	4.8	LBCН-2630
26.40	4.8	LBНУ-2640	4.7	LBНР-2640	4.8	LBCУ-2640	4.7	LBCП-2640	4.7	LBCМ-2640	5.8	LBСК-2640	4.8	LBCН-2640
26.50	4.8	LBНУ-2650	4.7	LBНР-2650	4.8	LBCУ-2650	4.7	LBCП-2650	4.7	LBCМ-2650	5.8	LBСК-2650	4.8	LBCН-2650
26.60	4.8	LBНУ-2660	4.7	LBНР-2660	4.8	LBCУ-2660	4.7	LBCП-2660	4.7	LBCМ-2660	5.8	LBСК-2660	4.8	LBCН-2660
26.70	4.9	LBНУ-2670	4.7	LBНР-2670	4.9	LBCУ-2670	4.7	LBCП-2670	4.7	LBCМ-2670	5.8	LBСК-2670	4.9	LBCН-2670
26.80	4.9	LBНУ-2680	4.8	LBНР-2680	4.9	LBCУ-2680	4.8	LBCП-2680	4.8	LBCМ-2680	5.8	LBСК-2680	4.9	LBCН-2680
26.90	4.9	LBНУ-2690	4.8	LBНР-2690	4.9	LBCУ-2690	4.8	LBCП-2690	4.8	LBCМ-2690	5.9	LBСК-2690	4.9	LBCН-2690
27.00	4.9	LBНУ-2700	4.8	LBНР-2700	4.9	LBCУ-2700	4.8	LBCП-2700	4.8	LBCМ-2700	5.9	LBСК-2700	4.9	LBCН-2700
27.10	4.9	LBНУ-2710	4.8	LBНР-2710	4.9	LBCУ-2710	4.8	LBCП-2710	4.8	LBCМ-2710	5.9	LBСК-2710	4.9	LBCН-2710
27.20	4.9	LBНУ-2720	4.8	LBНР-2720	4.9	LBCУ-2720	4.8	LBCП-2720	4.8	LBCМ-2720	5.9	LBСК-2720	4.9	LBCН-2720
27.30	5.0	LBНУ-2730	4.8	LBНР-2730	5.0	LBCУ-2730	4.8	LBCП-2730	4.8	LBCМ-2730	6.0	LBСК-2730	5.0	LBCН-2730
27.40	5.0	LBНУ-2740	4.9	LBНР-2740	5.0	LBCУ-2740	4.9	LBCП-2740	4.9	LBCМ-2740	6.0	LBСК-2740	5.0	LBCН-2740
27.50	5.0	LBНУ-2750	4.9	LBНР-2750	5.0	LBCУ-2750	4.9	LBCП-2750	4.9	LBCМ-2750	6.0	LBСК-2750	5.0	LBCН-2750
27.60	5.0	LBНУ-2760	4.9	LBНР-2760	5.0	LBCУ-2760	4.9	LBCП-2760	4.9	LBCМ-2760	6.0	LBСК-2760	5.0	LBCН-2760
27.70	5.0	LBНУ-2770	4.9	LBНР-2770	5.0	LBCУ-2770	4.9	LBCП-2770	4.9	LBCМ-2770	6.0	LBСК-2770	5.0	LBCН-2770
27.80	5.1	LBНУ-2780	4.9	LBНР-2780	5.1	LBCУ-2780	4.9	LBCП-2780	4.9	LBCМ-2780	6.1	LBСК-2780	5.1	LBCН-2780
27.90	5.1	LBНУ-2790	4.9	LBНР-2790	5.1	LBCУ-2790	4.9	LBCП-2790	4.9	LBCМ-2790	6.1	LBСК-2790	5.1	LBCН-2790
28.00	5.1	LBНУ-2800	5.0	LBНР-2800	5.1	LBCУ-2800	5.0	LBCП-2800	5.0	LBCМ-2800	6.1	LBСК-2800	5.1	LBCН-2800
28.10	5.1	LBНУ-2810	5.0	LBНР-2810	5.1	LBCУ-2810	5.0	LBCП-2810	5.0	LBCМ-2810	6.1	LBСК-2810	5.1	LBCН-2810
28.20	5.1	LBНУ-2820	5.0	LBНР-2820	5.1	LBCУ-2820	5.0	LBCП-2820	5.0	LBCМ-2820	6.1	LBСК-2820	5.1	LBCН-2820
28.30	5.2	LBНУ-2830	5.0	LBНР-2830	5.2	LBCУ-2830	5.0	LBCП-2830	5.0	LBCМ-2830	6.2	LBСК-2830	5.2	LBCН-2830
28.40	5.2	LBНУ-2840	5.0	LBНР-2840	5.2	LBCУ-2840	5.0	LBCП-2840	5.0	LBCМ-2840	6.2	LBСК-2840	5.2	LBCН-2840
28.50	5.2	LBНУ-2850	5.1	LBНР-2850	5.2	LBCУ-2850	5.1	LBCП-2850	5.1	LBCМ-2850	6.2	LBСК-2850	5.2	LBCН-2850
28.60	5.2	LBНУ-2860	5.1	LBНР-2860	5.2	LBCУ-2860	5.1	LBCП-2860	5.1	LBCМ-2860	6.2	LBСК-2860	5.2	LBCН-2860
28.70	5.2	LBНУ-2870	5.1	LBНР-2870	5.2	LBCУ-2870	5.1	LBCП-2870	5.1	LBCМ-2870	6.3	LBСК-2870	5.2	LBCН-2870
28.80	5.2	LBНУ-2880	5.1	LBНР-2880	5.2	LBCУ-2880	5.1	LBCП-2880	5.1	LBCМ-2880	6.3	LBСК-2880	5.2	LBCН-2880
28.90	5.3	LBНУ-2890	5.1	LBНР-2890	5.3	LBCУ-2890	5.1	LBCП-2890	5.1	LBCМ-2890	6.3	LBСК-2890	5.3	LBCН-2890
29.00	5.3	LBНУ-2900	5.1	LBНР-2900	5.3	LBCУ-2900	5.1	LBCП-2900	5.1	LBCМ-2900	6.3	LBСК-2900	5.3	LBCН-2900
29.10	5.3	LBНУ-2910	5.2	LBНР-2910	5.3	LBCУ-2910	5.2	LBCП-2910	5.2	LBCМ-2910	6.3	LBСК-2910	5.3	LBCН-2910
29.20	5.3	LBНУ-2920	5.2	LBНР-2920	5.3	LBCУ-2920	5.2	LBCП-2920	5.2	LBCМ-2920	6.4	LBСК-2920	5.3	LBCН-2920
29.30	5.3	LBНУ-2930	5.2	LBНР-2930	5.3	LBCУ-2930	5.2	LBCП-2930	5.2	LBCМ-2930	6.4	LBСК-2930	5.3	LBCН-2930
29.40	5.4	LBНУ-2940	5.2	LBНР-2940	5.4	LBCУ-2940	5.2	LBCП-2940	5.2	LBCМ-2940	6.4	LBСК-2940	5.4	LBCН-2940
29.50	5.4	LBНУ-2950	5.2	LBНР-2950	5.4	LBCУ-2950	5.2	LBCП-2950	5.2	LBCМ-2950	6.4	LBСК-2950	5.4	LBCН-2950
29.60	5.4	LBНУ-2960	5.2	LBНР-2960	5.4	LBCУ-2960	5.2	LBCП-2960	5.2	LBCМ-2960	6.5	LBСК-2960	5.4	LBCН-2960
29.70	5.4	LBНУ-2970	5.3	LBНР-2970	5.4	LBCУ-2970	5.3	LBCП-2970	5.3	LBCМ-2970	6.5	LBСК-2970	5.4	LBCН-2970
29.80	5.4	LBНУ-2980	5.3	LBНР-2980	5.4	LBCУ-2980	5.3	LBCП-2980	5.3	LBCМ-2980	6.5	LBСК-2980	5.4	LBCН-2980
29.90	5.4	LBНУ-2990	5.3	LBНР-2990	5.4	LBCУ-2990	5.3	LBCП-2990	5.3	LBCМ-2990	6.5	LBСК-2990	5.4	LBCН-2990
P1	<500N	☆	★	☆	★	☆	★	☆	★	☆	★	☆	★	☆
P2	<750N	★	★	★	★	★	★	★	★	★	★	★	★	★
P3	<1400N	★	★	★	★	★	★	★	★	★	★	★	★	★
P4	<1400N	☆	☆	☆	☆	☆	☆	☆	☆	☆	☆	☆	☆	☆
P5	<1200N	★	★	★	★	★	★	★	★	★	★	★	★	★
M	<900N	☆	☆	☆	☆	☆	☆	☆	☆	☆	☆	☆	☆	☆
K1	<750N	☆	☆	☆	☆	☆	☆	☆	☆	☆	☆	☆	☆	☆
K2	≤900N	☆	☆	☆	☆	☆	☆	☆	☆	☆	☆	☆	☆	☆
K3	<1100N	☆	☆	☆	☆	☆	☆	☆	☆	☆	☆	☆	☆	☆
N1	Si<12%	☆	☆	☆	☆	☆	☆	☆	☆	☆	☆	☆	☆	☆
N2	Si>12%	☆	☆	☆	☆	☆	☆	☆	☆	☆	☆	☆	☆	☆
N3	<750N	☆	☆	☆	☆	☆	☆	☆	☆	☆	☆	☆	☆	☆
N4		☆	☆	☆	☆	☆	☆	☆	☆	☆	☆	☆	☆	☆
S1	<1100N	☆	☆	☆	☆	☆	☆	☆	☆	☆	☆	☆	☆	☆
S2	<1100N	☆	☆	☆	☆	☆	☆	☆	☆	☆	☆	☆	☆	☆
H	<1600N	☆	☆	☆	☆	☆	☆	☆	☆	☆	☆	☆	☆	☆



СИСТЕМА СВЕРЛЕНИЯ «LightBreeze». ГОЛОВКИ

ПРОДОЛЖЕНИЕ ТАБЛИЦЫ

ВИДЫ ГОЛОВОК														
	HU		HP		CU		CP		CM		CK		CN	
ТИП	ASP2015		ASP2015		VHM		VHM		VHM		VHM		VHM	
МАТЕРИАЛ	ASP2015		ASP2015		VHM		VHM		VHM		VHM		VHM	
ПОКРЫТИЕ	Legend-nS		Legend-nS		Legend-nT		Legend-nS		Legend-nT		Legend-nT		DLC	
Ø мм	l мм	Артикул	l мм	Артикул	l мм	Артикул	l мм	Артикул	l мм	Артикул	l мм	Артикул	l мм	Артикул
30.00	5.5	LBHU-3000	5.3	LBHP-3000	5.5	LBCU-3000	5.3	LBCP-3000	5.3	LBCM-3000	6.5	LBCK-3000	5.5	LBCN-3000
30.10	5.5	LBHU-3010	5.3	LBHP-3010	5.5	LBCU-3010	5.3	LBCP-3010	5.3	LBCM-3010	6.6	LBCK-3010	5.5	LBCN-3010
30.20	5.5	LBHU-3020	5.4	LBHP-3020	5.5	LBCU-3020	5.4	LBCP-3020	5.4	LBCM-3020	6.6	LBCK-3020	5.5	LBCN-3020
30.30	5.5	LBHU-3030	5.4	LBHP-3030	5.5	LBCU-3030	5.4	LBCP-3030	5.4	LBCM-3030	6.6	LBCK-3030	5.5	LBCN-3030
30.40	5.5	LBHU-3040	5.4	LBHP-3040	5.5	LBCU-3040	5.4	LBCP-3040	5.4	LBCM-3040	6.6	LBCK-3040	5.5	LBCN-3040
30.50	5.6	LBHU-3050	5.4	LBHP-3050	5.6	LBCU-3050	5.4	LBCP-3050	5.4	LBCM-3050	6.6	LBCK-3050	5.6	LBCN-3050
30.60	5.6	LBHU-3060	5.4	LBHP-3060	5.6	LBCU-3060	5.4	LBCP-3060	5.4	LBCM-3060	6.7	LBCK-3060	5.6	LBCN-3060
30.70	5.6	LBHU-3070	5.4	LBHP-3070	5.6	LBCU-3070	5.4	LBCP-3070	5.4	LBCM-3070	6.7	LBCK-3070	5.6	LBCN-3070
30.80	5.6	LBHU-3080	5.5	LBHP-3080	5.6	LBCU-3080	5.5	LBCP-3080	5.5	LBCM-3080	6.7	LBCK-3080	5.6	LBCN-3080
30.90	5.6	LBHU-3090	5.5	LBHP-3090	5.6	LBCU-3090	5.5	LBCP-3090	5.5	LBCM-3090	6.7	LBCK-3090	5.6	LBCN-3090
31.00	5.6	LBHU-3100	5.5	LBHP-3100	5.6	LBCU-3100	5.5	LBCP-3100	5.5	LBCM-3100	6.8	LBCK-3100	5.6	LBCN-3100
31.10	5.7	LBHU-3110	5.5	LBHP-3110	5.7	LBCU-3110	5.5	LBCP-3110	5.5	LBCM-3110	6.8	LBCK-3110	5.7	LBCN-3110
31.20	5.7	LBHU-3120	5.5	LBHP-3120	5.7	LBCU-3120	5.5	LBCP-3120	5.5	LBCM-3120	6.8	LBCK-3120	5.7	LBCN-3120
31.30	5.7	LBHU-3130	5.5	LBHP-3130	5.7	LBCU-3130	5.5	LBCP-3130	5.5	LBCM-3130	6.8	LBCK-3130	5.7	LBCN-3130
31.40	5.7	LBHU-3140	5.6	LBHP-3140	5.7	LBCU-3140	5.6	LBCP-3140	5.6	LBCM-3140	6.8	LBCK-3140	5.7	LBCN-3140
31.50	5.7	LBHU-3150	5.6	LBHP-3150	5.7	LBCU-3150	5.6	LBCP-3150	5.6	LBCM-3150	6.9	LBCK-3150	5.7	LBCN-3150
31.60	5.8	LBHU-3160	5.6	LBHP-3160	5.8	LBCU-3160	5.6	LBCP-3160	5.6	LBCM-3160	6.9	LBCK-3160	5.8	LBCN-3160
31.70	5.8	LBHU-3170	5.6	LBHP-3170	5.8	LBCU-3170	5.6	LBCP-3170	5.6	LBCM-3170	6.9	LBCK-3170	5.8	LBCN-3170
31.80	5.8	LBHU-3180	5.6	LBHP-3180	5.8	LBCU-3180	5.6	LBCP-3180	5.6	LBCM-3180	6.9	LBCK-3180	5.8	LBCN-3180
31.90	5.8	LBHU-3190	5.7	LBHP-3190	5.8	LBCU-3190	5.7	LBCP-3190	5.7	LBCM-3190	7.0	LBCK-3190	5.8	LBCN-3190
32.00	5.8	LBHU-3200	5.7	LBHP-3200	5.8	LBCU-3200	5.7	LBCP-3200	5.7	LBCM-3200	7.0	LBCK-3200	5.8	LBCN-3200
32.10	5.8	LBHU-3210	5.7	LBHP-3210	5.8	LBCU-3210	5.7	LBCP-3210	5.7	LBCM-3210	7.0	LBCK-3210	5.8	LBCN-3210
32.20	5.9	LBHU-3220	5.7	LBHP-3220	5.9	LBCU-3220	5.7	LBCP-3220	5.7	LBCM-3220	7.0	LBCK-3220	5.9	LBCN-3220
32.30	5.9	LBHU-3230	5.7	LBHP-3230	5.9	LBCU-3230	5.7	LBCP-3230	5.7	LBCM-3230	7.0	LBCK-3230	5.9	LBCN-3230
32.40	5.9	LBHU-3240	5.7	LBHP-3240	5.9	LBCU-3240	5.7	LBCP-3240	5.7	LBCM-3240	7.1	LBCK-3240	5.9	LBCN-3240
32.50	5.9	LBHU-3250	5.8	LBHP-3250	5.9	LBCU-3250	5.8	LBCP-3250	5.8	LBCM-3250	7.1	LBCK-3250	5.9	LBCN-3250
32.60	5.9	LBHU-3260	5.8	LBHP-3260	5.9	LBCU-3260	5.8	LBCP-3260	5.8	LBCM-3260	7.1	LBCK-3260	5.9	LBCN-3260
32.70	6.0	LBHU-3270	5.8	LBHP-3270	6.0	LBCU-3270	5.8	LBCP-3270	5.8	LBCM-3270	7.1	LBCK-3270	6.0	LBCN-3270
32.80	6.0	LBHU-3280	5.8	LBHP-3280	6.0	LBCU-3280	5.8	LBCP-3280	5.8	LBCM-3280	7.1	LBCK-3280	6.0	LBCN-3280
32.90	6.0	LBHU-3290	5.8	LBHP-3290	6.0	LBCU-3290	5.8	LBCP-3290	5.8	LBCM-3290	7.2	LBCK-3290	6.0	LBCN-3290
33.00	6.0	LBHU-3300	5.9	LBHP-3300	6.0	LBCU-3300	5.9	LBCP-3300	5.9	LBCM-3300	7.2	LBCK-3300	6.0	LBCN-3300
33.10	6.0	LBHU-3310	5.9	LBHP-3310	6.0	LBCU-3310	5.9	LBCP-3310	5.9	LBCM-3310	7.2	LBCK-3310	6.0	LBCN-3310
33.20	6.0	LBHU-3320	5.9	LBHP-3320	6.0	LBCU-3320	5.9	LBCP-3320	5.9	LBCM-3320	7.2	LBCK-3320	6.0	LBCN-3320
33.30	6.1	LBHU-3330	5.9	LBHP-3330	6.1	LBCU-3330	5.9	LBCP-3330	5.9	LBCM-3330	7.3	LBCK-3330	6.1	LBCN-3330
33.40	6.1	LBHU-3340	5.9	LBHP-3340	6.1	LBCU-3340	5.9	LBCP-3340	5.9	LBCM-3340	7.3	LBCK-3340	6.1	LBCN-3340
33.50	6.1	LBHU-3350	5.9	LBHP-3350	6.1	LBCU-3350	5.9	LBCP-3350	5.9	LBCM-3350	7.3	LBCK-3350	6.1	LBCN-3350
33.60	6.1	LBHU-3360	6.0	LBHP-3360	6.1	LBCU-3360	6.0	LBCP-3360	6.0	LBCM-3360	7.3	LBCK-3360	6.1	LBCN-3360
33.70	6.1	LBHU-3370	6.0	LBHP-3370	6.1	LBCU-3370	6.0	LBCP-3370	6.0	LBCM-3370	7.3	LBCK-3370	6.1	LBCN-3370
33.80	6.2	LBHU-3380	6.0	LBHP-3380	6.2	LBCU-3380	6.0	LBCP-3380	6.0	LBCM-3380	7.4	LBCK-3380	6.2	LBCN-3380
33.90	6.2	LBHU-3390	6.0	LBHP-3390	6.2	LBCU-3390	6.0	LBCP-3390	6.0	LBCM-3390	7.4	LBCK-3390	6.2	LBCN-3390
P1 <500N		☆		★		☆		★		☆				
P2 <750N		★				★				☆				
P3 <1400N		★				★				☆				
P4 <1400N		☆				☆								
P5 <1200N		★				★				☆				
M <900N		☆				☆				★				
K1 <750N		☆		☆		☆		☆		☆		★		
K2 ≤900N		☆		☆		☆		☆		☆		★		
K3 <1100N		☆		☆		☆		☆		☆		★		
N1 Si<12%		☆				☆				☆		☆		★
N2 Si>12%		☆				☆				☆		☆		★
N3 <750N		☆				☆				☆		☆		★
N4		☆				☆				☆		☆		★
S1 <1100N		☆				☆								
S2 <1100N		☆				☆								
H <1600N						☆								









ПРОДОЛЖЕНИЕ ТАБЛИЦЫ

ВИДЫ ГОЛОВОК														
ТИП	НУ	НР	СУ	СП	СМ	СК	СН							
МАТЕРИАЛ	ASP2015	ASP2015	VHM	VHM	VHM	VHM	VHM	VHM						
ПОКРЫТИЕ	Legend-nS	Legend-nS	Legend-nT	Legend-nS	Legend-nT	Legend-nT	Legend-nT	DLC						
Д мм	l мм	Артикул	l мм	Артикул	l мм	Артикул	l мм	Артикул	l мм	Артикул				
34.00	6.2	LBHU-3400	6.0	LBHP-3400	6.2	LBCU-3400	6.0	LBSP-3400	6.0	LBCM-3400	7.4	LBCK-3400	6.2	LBCN-3400
34.10	6.2	LBHU-3410	6.0	LBHP-3410	6.2	LBCU-3410	6.0	LBSP-3410	6.0	LBCM-3410	7.4	LBCK-3410	6.2	LBCN-3410
34.20	6.2	LBHU-3420	6.1	LBHP-3420	6.2	LBCU-3420	6.1	LBSP-3420	6.1	LBCM-3420	7.5	LBCK-3420	6.2	LBCN-3420
34.30	6.2	LBHU-3430	6.1	LBHP-3430	6.2	LBCU-3430	6.1	LBSP-3430	6.1	LBCM-3430	7.5	LBCK-3430	6.2	LBCN-3430
34.40	6.3	LBHU-3440	6.1	LBHP-3440	6.3	LBCU-3440	6.1	LBSP-3440	6.1	LBCM-3440	7.5	LBCK-3440	6.3	LBCN-3440
34.50	6.3	LBHU-3450	6.1	LBHP-3450	6.3	LBCU-3450	6.1	LBSP-3450	6.1	LBCM-3450	7.5	LBCK-3450	6.3	LBCN-3450
34.60	6.3	LBHU-3460	6.1	LBHP-3460	6.3	LBCU-3460	6.1	LBSP-3460	6.1	LBCM-3460	7.5	LBCK-3460	6.3	LBCN-3460
34.70	6.3	LBHU-3470	6.2	LBHP-3470	6.3	LBCU-3470	6.2	LBSP-3470	6.2	LBCM-3470	7.6	LBCK-3470	6.3	LBCN-3470
34.80	6.3	LBHU-3480	6.2	LBHP-3480	6.3	LBCU-3480	6.2	LBSP-3480	6.2	LBCM-3480	7.6	LBCK-3480	6.3	LBCN-3480
34.90	6.4	LBHU-3490	6.2	LBHP-3490	6.4	LBCU-3490	6.2	LBSP-3490	6.2	LBCM-3490	7.6	LBCK-3490	6.4	LBCN-3490
35.00	6.4	LBHU-3500	6.2	LBHP-3500	6.4	LBCU-3500	6.2	LBSP-3500	6.2	LBCM-3500	7.6	LBCK-3500	6.4	LBCN-3500
35.10	6.4	LBHU-3510	6.2	LBHP-3510	6.4	LBCU-3510	6.2	LBSP-3510	6.2	LBCM-3510	7.7	LBCK-3510	6.4	LBCN-3510
35.20	6.4	LBHU-3520	6.2	LBHP-3520	6.4	LBCU-3520	6.2	LBSP-3520	6.2	LBCM-3520	7.7	LBCK-3520	6.4	LBCN-3520
35.30	6.4	LBHU-3530	6.3	LBHP-3530	6.4	LBCU-3530	6.3	LBSP-3530	6.3	LBCM-3530	7.7	LBCK-3530	6.4	LBCN-3530
35.40	6.4	LBHU-3540	6.3	LBHP-3540	6.4	LBCU-3540	6.3	LBSP-3540	6.3	LBCM-3540	7.7	LBCK-3540	6.4	LBCN-3540
35.50	6.5	LBHU-3550	6.3	LBHP-3550	6.5	LBCU-3550	6.3	LBSP-3550	6.3	LBCM-3550	7.7	LBCK-3550	6.5	LBCN-3550
35.60	6.5	LBHU-3560	6.3	LBHP-3560	6.5	LBCU-3560	6.3	LBSP-3560	6.3	LBCM-3560	7.8	LBCK-3560	6.5	LBCN-3560
35.70	6.5	LBHU-3570	6.3	LBHP-3570	6.5	LBCU-3570	6.3	LBSP-3570	6.3	LBCM-3570	7.8	LBCK-3570	6.5	LBCN-3570
35.80	6.5	LBHU-3580	6.3	LBHP-3580	6.5	LBCU-3580	6.3	LBSP-3580	6.3	LBCM-3580	7.8	LBCK-3580	6.5	LBCN-3580
35.90	6.5	LBHU-3590	6.4	LBHP-3590	6.5	LBCU-3590	6.4	LBSP-3590	6.4	LBCM-3590	7.8	LBCK-3590	6.5	LBCN-3590
36.00	6.6	LBHU-3600	6.4	LBHP-3600	6.6	LBCU-3600	6.4	LBSP-3600	6.4	LBCM-3600	7.8	LBCK-3600	6.6	LBCN-3600
36.10	6.6	LBHU-3610	6.4	LBHP-3610	6.6	LBCU-3610	6.4	LBSP-3610	6.4	LBCM-3610	7.9	LBCK-3610	6.6	LBCN-3610
36.20	6.6	LBHU-3620	6.4	LBHP-3620	6.6	LBCU-3620	6.4	LBSP-3620	6.4	LBCM-3620	7.9	LBCK-3620	6.6	LBCN-3620
36.30	6.6	LBHU-3630	6.4	LBHP-3630	6.6	LBCU-3630	6.4	LBSP-3630	6.4	LBCM-3630	7.9	LBCK-3630	6.6	LBCN-3630
36.40	6.6	LBHU-3640	6.5	LBHP-3640	6.6	LBCU-3640	6.5	LBSP-3640	6.5	LBCM-3640	7.9	LBCK-3640	6.6	LBCN-3640
36.50	6.6	LBHU-3650	6.5	LBHP-3650	6.6	LBCU-3650	6.5	LBSP-3650	6.5	LBCM-3650	8.0	LBCK-3650	6.6	LBCN-3650
36.60	6.7	LBHU-3660	6.5	LBHP-3660	6.7	LBCU-3660	6.5	LBSP-3660	6.5	LBCM-3660	8.0	LBCK-3660	6.7	LBCN-3660
36.70	6.7	LBHU-3670	6.5	LBHP-3670	6.7	LBCU-3670	6.5	LBSP-3670	6.5	LBCM-3670	8.0	LBCK-3670	6.7	LBCN-3670
36.80	6.7	LBHU-3680	6.5	LBHP-3680	6.7	LBCU-3680	6.5	LBSP-3680	6.5	LBCM-3680	8.0	LBCK-3680	6.7	LBCN-3680
36.90	6.7	LBHU-3690	6.5	LBHP-3690	6.7	LBCU-3690	6.5	LBSP-3690	6.5	LBCM-3690	8.0	LBCK-3690	6.7	LBCN-3690
37.00	6.7	LBHU-3700	6.6	LBHP-3700	6.7	LBCU-3700	6.6	LBSP-3700	6.6	LBCM-3700	8.1	LBCK-3700	6.7	LBCN-3700
37.10	6.8	LBHU-3710	6.6	LBHP-3710	6.8	LBCU-3710	6.6	LBSP-3710	6.6	LBCM-3710	8.1	LBCK-3710	6.8	LBCN-3710
37.20	6.8	LBHU-3720	6.6	LBHP-3720	6.8	LBCU-3720	6.6	LBSP-3720	6.6	LBCM-3720	8.1	LBCK-3720	6.8	LBCN-3720
37.30	6.8	LBHU-3730	6.6	LBHP-3730	6.8	LBCU-3730	6.6	LBSP-3730	6.6	LBCM-3730	8.1	LBCK-3730	6.8	LBCN-3730
37.40	6.8	LBHU-3740	6.6	LBHP-3740	6.8	LBCU-3740	6.6	LBSP-3740	6.6	LBCM-3740	8.2	LBCK-3740	6.8	LBCN-3740
37.50	6.8	LBHU-3750	6.6	LBHP-3750	6.8	LBCU-3750	6.6	LBSP-3750	6.6	LBCM-3750	8.2	LBCK-3750	6.8	LBCN-3750
37.60	6.8	LBHU-3760	6.7	LBHP-3760	6.8	LBCU-3760	6.7	LBSP-3760	6.7	LBCM-3760	8.2	LBCK-3760	6.8	LBCN-3760
37.70	6.9	LBHU-3770	6.7	LBHP-3770	6.9	LBCU-3770	6.7	LBSP-3770	6.7	LBCM-3770	8.2	LBCK-3770	6.9	LBCN-3770
37.80	6.9	LBHU-3780	6.7	LBHP-3780	6.9	LBCU-3780	6.7	LBSP-3780	6.7	LBCM-3780	8.2	LBCK-3780	6.9	LBCN-3780
37.90	6.9	LBHU-3790	6.7	LBHP-3790	6.9	LBCU-3790	6.7	LBSP-3790	6.7	LBCM-3790	8.3	LBCK-3790	6.9	LBCN-3790
P1	<500N	☆		★		☆		★		☆				
P2	<750N	★				★				☆				
P3	<1400N	★				★				☆				
P4	<1400N	☆				☆								
P5	<1200N	★				★				☆				
M	<900N	☆				☆				★				
K1	<750N	☆		☆		☆		☆		☆		★		
K2	≤900N	☆		☆		☆		☆		☆		★		
K3	<1100N	☆		☆		☆		☆		☆		★		
N1	Si<12%	☆				☆				☆		☆		★
N2	Si>12%	☆				☆				☆		☆		★
N3	<750N	☆				☆				☆		☆		★
N4		☆				☆				☆		☆		★
S1	<1100N	☆				☆								
S2	<1100N	☆				☆								
H	<1600N					☆								



СИСТЕМА СВЕРЛЕНИЯ «LightBreeze». ГОЛОВКИ

ОКОНЧАНИЕ ТАБЛИЦЫ

ВИДЫ ГОЛОВОК														
ТИП	НУ	НР	СУ	СП	СМ	СК	СН							
МАТЕРИАЛ	ASP2015	ASP2015	VHM	VHM	VHM	VHM	VHM							
ПОКРЫТИЕ	Legend-nS	Legend-nS	Legend-nT	Legend-nS	Legend-nT	Legend-nT	DLC							
Д мм	L мм	Артикул	L мм	Артикул	L мм	Артикул	L мм	Артикул						
38.00	6.9	LBHU-3800	6.7	LBHP-3800	6.9	LBCU-3800	6.7	LBCP-3800	6.7	LBCM-3800	8.3	LBCK-3800	6.9	LBCN-3800
38.10	6.9	LBHU-3810	6.8	LBHP-3810	6.9	LBCU-3810	6.8	LBCP-3810	6.8	LBCM-3810	8.3	LBCK-3810	6.9	LBCN-3810
38.20	7.0	LBHU-3820	6.8	LBHP-3820	7.0	LBCU-3820	6.8	LBCP-3820	6.8	LBCM-3820	8.3	LBCK-3820	7.0	LBCN-3820
38.30	7.0	LBHU-3830	6.8	LBHP-3830	7.0	LBCU-3830	6.8	LBCP-3830	6.8	LBCM-3830	8.3	LBCK-3830	7.0	LBCN-3830
38.40	7.0	LBHU-3840	6.8	LBHP-3840	7.0	LBCU-3840	6.8	LBCP-3840	6.8	LBCM-3840	8.4	LBCK-3840	7.0	LBCN-3840
38.50	7.0	LBHU-3850	6.8	LBHP-3850	7.0	LBCU-3850	6.8	LBCP-3850	6.8	LBCM-3850	8.4	LBCK-3850	7.0	LBCN-3850
38.60	7.0	LBHU-3860	6.8	LBHP-3860	7.0	LBCU-3860	6.8	LBCP-3860	6.8	LBCM-3860	8.4	LBCK-3860	7.0	LBCN-3860
38.70	7.0	LBHU-3870	6.9	LBHP-3870	7.0	LBCU-3870	6.9	LBCP-3870	6.9	LBCM-3870	8.4	LBCK-3870	7.0	LBCN-3870
38.80	7.1	LBHU-3880	6.9	LBHP-3880	7.1	LBCU-3880	6.9	LBCP-3880	6.9	LBCM-3880	8.5	LBCK-3880	7.1	LBCN-3880
38.90	7.1	LBHU-3890	6.9	LBHP-3890	7.1	LBCU-3890	6.9	LBCP-3890	6.9	LBCM-3890	8.5	LBCK-3890	7.1	LBCN-3890
39.00	7.1	LBHU-3900	6.9	LBHP-3900	7.1	LBCU-3900	6.9	LBCP-3900	6.9	LBCM-3900	8.5	LBCK-3900	7.1	LBCN-3900
39.10	7.1	LBHU-3910	6.9	LBHP-3910	7.1	LBCU-3910	6.9	LBCP-3910	6.9	LBCM-3910	8.5	LBCK-3910	7.1	LBCN-3910
39.20	7.1	LBHU-3920	7.0	LBHP-3920	7.1	LBCU-3920	7.0	LBCP-3920	7.0	LBCM-3920	8.5	LBCK-3920	7.1	LBCN-3920
39.30	7.2	LBHU-3930	7.0	LBHP-3930	7.2	LBCU-3930	7.0	LBCP-3930	7.0	LBCM-3930	8.6	LBCK-3930	7.2	LBCN-3930
39.40	7.2	LBHU-3940	7.0	LBHP-3940	7.2	LBCU-3940	7.0	LBCP-3940	7.0	LBCM-3940	8.6	LBCK-3940	7.2	LBCN-3940
39.50	7.2	LBHU-3950	7.0	LBHP-3950	7.2	LBCU-3950	7.0	LBCP-3950	7.0	LBCM-3950	8.6	LBCK-3950	7.2	LBCN-3950
39.60	7.2	LBHU-3960	7.0	LBHP-3960	7.2	LBCU-3960	7.0	LBCP-3960	7.0	LBCM-3960	8.6	LBCK-3960	7.2	LBCN-3960
39.70	7.2	LBHU-3970	7.0	LBHP-3970	7.2	LBCU-3970	7.0	LBCP-3970	7.0	LBCM-3970	8.7	LBCK-3970	7.2	LBCN-3970
39.80	7.2	LBHU-3980	7.1	LBHP-3980	7.2	LBCU-3980	7.1	LBCP-3980	7.1	LBCM-3980	8.7	LBCK-3980	7.2	LBCN-3980
39.90	7.3	LBHU-3990	7.1	LBHP-3990	7.3	LBCU-3990	7.1	LBCP-3990	7.1	LBCM-3990	8.7	LBCK-3990	7.3	LBCN-3990
39.99	—	—	7.1	LBHP-3999	7.3	LBCU-3999	7.1	LBCP-3999	7.1	LBCM-3999	8.7	LBCK-3999	7.3	LBCN-3999
P1 <500N		☆		★		☆		★		☆				
P2 <750N		★				★				☆				
P3 <1400N		★				★				☆				
P4 <1400N		☆				☆								
P5 <1200N		★				★				☆				
M <900N		☆				☆				★				
K1 <750N		☆		☆		☆		☆		☆		★		
K2 ≤900N		☆		☆		☆		☆		☆		★		
K3 <1100N		☆		☆		☆		☆		☆		★		
N1 Si<12%		☆				☆				☆		☆		★
N2 Si>12%		☆				☆				☆		☆		★
N3 <750N		☆				☆				☆		☆		★
N4		☆				☆				☆		☆		★
S1 <1100N		☆				☆								
S2 <1100N		☆				☆								
H <1600N						☆								

РЕКОМЕНДУЕМЫЕ РЕЖИМЫ РЕЗАНИЯ ДЛЯ ГОЛОВОК ИЗ ПОРОШКОВОЙ БЫСТРОРЕЖУЩЕЙ СТАЛИ ASP2015

ISO	Материалы	Состояние	Предел прочности (Н/мм²)	Твердость	Рекомендуемый тип головок	Скорость резания Vc (м/мин)	Подача (мм/об) и диаметр сверла							
							10.00-11.99	12.00-13.99	14.00-15.99	16.00-19.99	20.00-25.99	26.00-32.99	33.00-39.99	
P	P1 Нелегированная сталь, литье, легкообрабатываемая сталь	<0.25%С	Отожженные	370-500	100-150	HP	38-70	0.10-0.19	0.11-0.21	0.14-0.26	0.18-0.33	0.19-0.36	0.21-0.40	0.22-0.42
		≥0.25%С	Отожженные	600-775	175-225	HP	35-64	0.10-0.19	0.11-0.21	0.14-0.26	0.18-0.33	0.19-0.36	0.21-0.40	0.22-0.42
		<0.55%С		775-940	225-275	HU	32-59	0.10-0.19	0.11-0.21	0.14-0.26	0.18-0.33	0.19-0.36	0.21-0.40	0.22-0.42
		≥0.55%С	Отожженные	940-1090	275-325	HU	25-47	0.10-0.19	0.11-0.21	0.14-0.26	0.18-0.33	0.19-0.36	0.21-0.40	0.22-0.42
			Закалённые и отпущенные	1000	300	HU	22-41	0.09-0.17	0.10-0.19	0.13-0.24	0.17-0.31	0.18-0.33	0.20-0.37	0.21-0.40
	P2 Низколегированная сталь и литье (менее 5% легирующих добавок)		Отожженные	600-775	175-225	HU	33-62	0.10-0.19	0.11-0.21	0.13-0.25	0.17-0.31	0.20-0.36	0.22-0.42	0.25-0.47
			Закалённые и отпущенные	775-940	225-275	HU	32-59	0.10-0.19	0.11-0.21	0.13-0.25	0.17-0.31	0.20-0.36	0.22-0.42	0.25-0.47
			Отожженные	940-1090	275-325	HU	28-53	0.10-0.18	0.11-0.20	0.13-0.24	0.16-0.30	0.19-0.35	0.22-0.41	0.25-0.46
			Закалённые и отпущенные	1090-1265	325-375	HU	24-44	0.09-0.17	0.10-0.19	0.12-0.23	0.16-0.29	0.18-0.34	0.21-0.40	0.24-0.45
	P3 Высоколегированная сталь, литье и инструментальная сталь		Отожженные	600-1020	225-300	HU	22-41	0.09-0.17	0.11-0.20	0.12-0.23	0.14-0.26	0.17-0.31	0.17-0.31	0.18-0.33
			Закалённые	1020-1180	300-350	HU	19-35	0.09-0.17	0.11-0.20	0.12-0.23	0.14-0.26	0.17-0.31	0.17-0.31	0.18-0.33
	P4 Износостойкие пластины (Hardox, AR400, T-1)			1365	400	HU	7-13	0.06-0.10	0.07-0.13	0.07-0.13	0.08-0.16	0.10-0.18	0.11-0.21	0.11-0.21
				1600	500		—	—	—	—	—	—	—	—
	P5 Нержавеющая сталь		Ферритные/Мартенситные	640-940	185-275	HU	16-29	0.10-0.18	0.11-0.21	0.13-0.23	0.17-0.31	0.20-0.36	0.20-0.36	0.20-0.36
				940-1180	275-350	HU	19-35	0.08-0.16	0.08-0.16	0.10-0.18	0.13-0.23	0.15-0.29	0.15-0.29	0.15-0.29
M	Нержавеющая сталь и литье	N<0.1%	Аустенитные	480-640	135-185	HU	18-32	0.08-0.16	0.08-0.16	0.10-0.18	0.11-0.21	0.13-0.23	0.13-0.23	0.13-0.23
				640-940	185-275	HU	18-32	0.08-0.16	0.08-0.16	0.10-0.18	0.11-0.21	0.13-0.23	0.13-0.23	0.13-0.23
		N≥0.1%	Дуплексные	480-640	135-185	HU	19-35	0.08-0.16	0.08-0.16	0.10-0.18	0.11-0.21	0.11-0.21	0.11-0.21	0.11-0.21
				640-940	185-275	HU	16-29	0.08-0.16	0.08-0.16	0.10-0.18	0.11-0.21	0.11-0.21	0.11-0.21	0.11-0.21
K	K1 Серый чугун (GG)		Ферритный	430-500	120-150	HU, HP	38-70	0.18-0.33	0.20-0.38	0.26-0.48	0.28-0.53	0.32-0.59	0.34-0.63	0.35-0.65
			Перлитный	500-700	150-200	HU, HP	35-64	0.18-0.33	0.20-0.38	0.26-0.48	0.28-0.53	0.32-0.59	0.34-0.63	0.35-0.65
	K2 Чугун с шаровидным графитом (GGG)		Ферритный	700-755	200-220	HU, HP	32-59	0.18-0.33	0.20-0.38	0.26-0.48	0.28-0.53	0.32-0.59	0.34-0.63	0.35-0.65
			Перлитный	755-890	220-260	HU, HP	32-59	0.18-0.33	0.20-0.38	0.26-0.48	0.28-0.53	0.32-0.59	0.34-0.63	0.35-0.65
	K3 Ковкий чугун		Ферритный	430-500	120-150	HU, HP	32-59	0.18-0.33	0.20-0.38	0.26-0.48	0.28-0.53	0.32-0.59	0.34-0.63	0.35-0.65
			Перлитный	890-1020	260-320	HU, HP	32-59	0.18-0.33	0.20-0.38	0.26-0.48	0.28-0.53	0.32-0.59	0.34-0.63	0.35-0.65
N	N1 Деформируемые алюминиевые сплавы		Неструктурированные	100	30	HU	47-88	0.18-0.33	0.20-0.36	0.26-0.48	0.28-0.52	0.32-0.59	0.35-0.65	0.39-0.72
			Структурированные	600	180	HU	41-76	0.18-0.33	0.20-0.36	0.26-0.48	0.28-0.52	0.32-0.59	0.35-0.65	0.39-0.72
	N2 Алюминий - литье, легированный сплав	<12% Si	Неструктурированные	100	30	HU	47-88	0.18-0.33	0.20-0.36	0.26-0.48	0.28-0.52	0.32-0.59	0.35-0.65	0.39-0.72
		>12% Si	Структурированные	600	180	HU	41-76	0.18-0.33	0.20-0.36	0.26-0.48	0.28-0.52	0.32-0.59	0.35-0.65	0.39-0.72
	N3 Сплавы меди	>1% Pb	Легкообрабатываемые	370-670	100-200	HU	47-88	0.18-0.33	0.20-0.36	0.26-0.48	0.28-0.52	0.32-0.59	0.35-0.65	0.39-0.72
			Латунь	670-855	200-250	HU	47-88	0.18-0.33	0.20-0.36	0.26-0.48	0.28-0.52	0.32-0.59	0.35-0.65	0.39-0.72
			Электролитная медь	370	100	HU	47-88	0.18-0.33	0.20-0.36	0.26-0.48	0.28-0.52	0.32-0.59	0.35-0.65	0.39-0.72
	N4 Неметаллические материалы		Реактопласты, волокниты	—	—	HU	47-88	0.18-0.33	0.20-0.36	0.26-0.48	0.28-0.52	0.32-0.59	0.35-0.65	0.39-0.72
			Твердая резина	200	60	HU	47-88	0.18-0.33	0.20-0.36	0.26-0.48	0.28-0.52	0.32-0.59	0.35-0.65	0.39-0.72
	S	S1 Жаропрочные сплавы	На основе железа	Отожженные	480-755	140-220	HU	14-27	0.06-0.10	0.07-0.13	0.10-0.18	0.11-0.21	0.13-0.23	0.14-0.26
Структурированные				755-990	223-310	HU	11-21	0.06-0.10	0.07-0.13	0.10-0.18	0.11-0.21	0.13-0.23	0.14-0.26	0.15-0.29
На основе никеля или кобальта			Отожженные	—	250	HU	11-21	0.06-0.10	0.07-0.13	0.10-0.18	0.11-0.21	0.13-0.23	0.14-0.26	0.15-0.29
			Структурированные	—	350	HU	11-21	0.06-0.10	0.07-0.13	0.10-0.18	0.11-0.21	0.13-0.23	0.14-0.26	0.15-0.29
S2 Титановые сплавы				RM 400	320	HU	11-21	0.06-0.10	0.07-0.13	0.10-0.18	0.11-0.21	0.13-0.23	0.14-0.26	0.15-0.29
		Альфа и бета сплавы	RM 1050	—	HU	11-21	0.06-0.10	0.07-0.13	0.10-0.18	0.11-0.21	0.13-0.23	0.14-0.26	0.15-0.29	
H	Закаленная сталь			1020-1365	300-400	HU	9-16	0.06-0.10	0.07-0.13	0.07-0.13	0.08-0.16	0.10-0.18	0.11-0.21	0.11-0.21
				1365+	400-500		—	—	—	—	—	—	—	—

РЕКОМЕНДОВАННЫЕ ЗНАЧЕНИЯ ПАРАМЕТРОВ РЕЗАНИЯ, ПРЕДСТАВЛЕННЫЕ В ТАБЛИЦЕ, ЯВЛЯЮТСЯ ОРИЕНТИРОВОЧНЫМИ И ДОЛЖНЫ ПРИМЕНЯТЬСЯ И КОРРЕКТИРОВАТЬСЯ В ЗАВИСИМОСТИ ОТ КОНКРЕТНЫХ УСЛОВИЙ СВЕРЛЕНИЯ.

РЕКОМЕНДУЕМЫЕ РЕЖИМЫ РЕЗАНИЯ ДЛЯ ГОЛОВЕК ИЗ ТВЕРДОГО СПЛАВА

ISO	Материалы	Состояние	Предел прочности (Н/мм ²)	Твердость	Рекомендуемый тип головок	Скорость резания V _c (м/мин)	Подача (мм/об) и диаметр сверла							
							10.00-11.99	12.00-13.99	14.00-15.99	16.00-19.99	20.00-25.99	26.00-32.99	33.00-39.99	
P	P1 Нелегированная сталь, литье, легкообрабатываемая сталь	<0.25%С	Отожженные	370-500	100-150	CP	84-156	0.10-0.19	0.11-0.21	0.14-0.26	0.18-0.33	0.19-0.36	0.21-0.40	0.22-0.42
		≥0.25%С	Отожженные	600-775	175-225	CP	77-143	0.10-0.19	0.11-0.21	0.14-0.26	0.18-0.33	0.19-0.36	0.21-0.40	0.22-0.42
		<0.55%С		775-940	225-275	CU	70-130	0.10-0.19	0.11-0.21	0.14-0.26	0.18-0.33	0.19-0.36	0.21-0.40	0.22-0.42
		≥0.55%С	Отожженные	940-1090	275-325	CU	56-104	0.10-0.19	0.11-0.21	0.14-0.26	0.18-0.33	0.19-0.36	0.21-0.40	0.22-0.42
		Закаленные и отпущенные	1000	300	CU	49-91	0.09-0.17	0.10-0.19	0.13-0.24	0.17-0.31	0.18-0.33	0.20-0.37	0.21-0.40	
	P2 Низколегированная сталь и литье (менее 5% легирующих добавок)		Отожженные	600-775	175-225	CU	74-137	0.10-0.19	0.11-0.21	0.13-0.25	0.17-0.31	0.20-0.36	0.22-0.42	0.25-0.47
			Закаленные и отпущенные	775-940	225-275	CU	70-130	0.10-0.19	0.11-0.21	0.13-0.25	0.17-0.31	0.20-0.36	0.22-0.42	0.25-0.47
			Отожженные	940-1090	275-325	CU	63-117	0.10-0.18	0.11-0.20	0.13-0.24	0.16-0.30	0.19-0.35	0.22-0.41	0.25-0.46
			Закаленные и отпущенные	1090-1265	325-375	CU	53-98	0.09-0.17	0.10-0.19	0.12-0.23	0.16-0.29	0.18-0.34	0.21-0.40	0.24-0.45
	P3 Высоколегированная сталь, литье и инструментальная сталь		Отожженные	600-1020	225-300	CU	49-91	0.09-0.17	0.11-0.20	0.12-0.23	0.14-0.26	0.17-0.31	0.17-0.31	0.18-0.33
			Закаленные	1020-1180	300-350	CU	42-78	0.09-0.17	0.11-0.20	0.12-0.23	0.14-0.26	0.17-0.31	0.17-0.31	0.18-0.33
	P4 Износостойкие пластины (Hardox, AR400, T-1)			1365	400	CU	21-39	0.06-0.10	0.07-0.13	0.07-0.13	0.08-0.16	0.10-0.18	0.11-0.21	0.11-0.21
			1600	500	CU	15-30	0.06-0.10	0.07-0.13	0.07-0.13	0.08-0.16	0.10-0.18	0.11-0.21	0.11-0.21	
P5 Нержавеющая сталь		Ферритные/Мартенситные	640-940	185-275	CU	30-50	0.10-0.18	0.11-0.21	0.13-0.23	0.17-0.31	0.20-0.36	0.20-0.36	0.20-0.36	
			940-1180	275-350	CU	60-90	0.08-0.16	0.08-0.16	0.10-0.18	0.13-0.23	0.15-0.29	0.15-0.29	0.15-0.29	
M	Нержавеющая сталь и литье	Аустенитные	480-640	135-185	CM	40-60	0.08-0.16	0.08-0.16	0.10-0.18	0.11-0.21	0.13-0.23	0.14-0.26	0.16-0.30	
			640-940	185-275	CM	50-70	0.08-0.16	0.08-0.16	0.10-0.18	0.11-0.21	0.13-0.23	0.14-0.26	0.16-0.30	
		N<0.1% N≥0.1%	Дуплексные	480-640	135-185	CM	40-70	0.07-0.13	0.07-0.13	0.08-0.16	0.10-0.18	0.11-0.21	0.11-0.21	0.13-0.25
				640-940	185-275	CM	20-60	0.06-0.12	0.06-0.12	0.07-0.13	0.08-0.16	0.10-0.18	0.10-0.18	0.12-0.22
K	K1 Серый чугун (GG)	Ферритный	430-500	120-150	CK	76-140	0.18-0.33	0.20-0.38	0.26-0.48	0.28-0.53	0.32-0.59	0.34-0.63	0.35-0.65	
		Перлитный	500-700	150-200	CK	69-129	0.18-0.33	0.20-0.38	0.26-0.48	0.28-0.53	0.32-0.59	0.34-0.63	0.35-0.65	
	K2 Чугун с шаровидным графитом (GGG)	Ферритный	700-755	200-220	CK	63-117	0.18-0.33	0.20-0.38	0.26-0.48	0.28-0.53	0.32-0.59	0.34-0.63	0.35-0.65	
		Перлитный	755-890	220-260	CK	63-117	0.18-0.33	0.20-0.38	0.26-0.48	0.28-0.53	0.32-0.59	0.34-0.63	0.35-0.65	
	K3 Ковкий чугун	Ферритный	430-500	120-150	CK	63-117	0.18-0.33	0.20-0.38	0.26-0.48	0.28-0.53	0.32-0.59	0.34-0.63	0.35-0.65	
		Перлитный	890-1020	260-320	CK	63-117	0.18-0.33	0.20-0.38	0.26-0.48	0.28-0.53	0.32-0.59	0.34-0.63	0.35-0.65	
N	N1 Деформируемые алюминиевые сплавы	Неструктурированные	100	30	CN	105-195	0.18-0.33	0.20-0.36	0.26-0.48	0.28-0.52	0.32-0.59	0.35-0.65	0.39-0.72	
		Структурированные	600	180	CN	91-169	0.18-0.33	0.20-0.36	0.26-0.48	0.28-0.52	0.32-0.59	0.35-0.65	0.39-0.72	
	N2 Алюминий - литье, легированный сплав	≤12% Si	Неструктурированные	100	30	CN	105-195	0.18-0.33	0.20-0.36	0.26-0.48	0.28-0.52	0.32-0.59	0.35-0.65	0.39-0.72
			Структурированные	600	180	CN	91-169	0.18-0.33	0.20-0.36	0.26-0.48	0.28-0.52	0.32-0.59	0.35-0.65	0.39-0.72
		>12% Si	Жаропрочные сплавы	—	—	CN	91-169	0.18-0.33	0.20-0.36	0.26-0.48	0.28-0.52	0.32-0.59	0.35-0.65	0.39-0.72
	N3 Сплавы меди	>1% Pb	Легкообрабатываемые	370-670	100-200	CN	105-195	0.18-0.33	0.20-0.36	0.26-0.48	0.28-0.52	0.32-0.59	0.35-0.65	0.39-0.72
			Латунь	670-855	200-250	CN	105-195	0.18-0.33	0.20-0.36	0.26-0.48	0.28-0.52	0.32-0.59	0.35-0.65	0.39-0.72
			Электролитная медь	370	100	CN	105-195	0.18-0.33	0.20-0.36	0.26-0.48	0.28-0.52	0.32-0.59	0.35-0.65	0.39-0.72
	N4 Неметаллические материалы		Реактопласты, волокниты	—		CN	105-195	0.18-0.33	0.20-0.36	0.26-0.48	0.28-0.52	0.32-0.59	0.35-0.65	0.39-0.72
			Твердая резина	200	60	CN	105-195	0.18-0.33	0.20-0.36	0.26-0.48	0.28-0.52	0.32-0.59	0.35-0.65	0.39-0.72
S	S1 Жаропрочные сплавы	На основе железа	Отожженные	480-755	140-220	CU	32-59	0.06-0.10	0.07-0.13	0.10-0.18	0.11-0.21	0.13-0.23	0.14-0.26	0.15-0.29
				Структурированные	755-990	223-310	CU	25-46	0.06-0.10	0.07-0.13	0.10-0.18	0.11-0.21	0.13-0.23	0.14-0.26
		На основе никеля или кобальта	Отожженные	—	250	CU	25-46	0.06-0.10	0.07-0.13	0.10-0.18	0.11-0.21	0.13-0.23	0.14-0.26	0.15-0.29
				Структурированные	—	350	CU	25-46	0.06-0.10	0.07-0.13	0.10-0.18	0.11-0.21	0.13-0.23	0.14-0.26
	S2 Титановые сплавы			Rm 400	320	CU	25-46	0.06-0.10	0.07-0.13	0.10-0.18	0.11-0.21	0.13-0.23	0.14-0.26	0.15-0.29
			Альфа и бета сплавы	Rm 1050		CU	25-46	0.06-0.10	0.07-0.13	0.10-0.18	0.11-0.21	0.13-0.23	0.14-0.26	0.15-0.29
H	Закаленная сталь		1020-1365	300-400	CU	28-52	0.06-0.10	0.07-0.13	0.07-0.13	0.08-0.16	0.10-0.18	0.11-0.21	0.11-0.21	
			1365+	400-500	CU	18-35	0.06-0.10	0.07-0.13	0.07-0.13	0.08-0.16	0.10-0.18	0.11-0.21	0.11-0.21	

РЕКОМЕНДОВАННЫЕ ЗНАЧЕНИЯ ПАРАМЕТРОВ РЕЗАНИЯ, ПРЕДСТАВЛЕННЫЕ В ТАБЛИЦЕ, ЯВЛЯЮТСЯ ОРИЕНТИРОВОЧНЫМИ И ДОЛЖНЫ ПРИМЕНЯТЬСЯ И КОРРЕКТИРОВАТЬСЯ В ЗАВИСИМОСТИ ОТ КОНКРЕТНЫХ УСЛОВИЙ СВЕРЛЕНИЯ.

ОПРАВКА СО СКОльзящей МУФТОЙ И ХВОСТОВИКОМ КМ ДЛЯ СВЕРЛ. ISO 9766

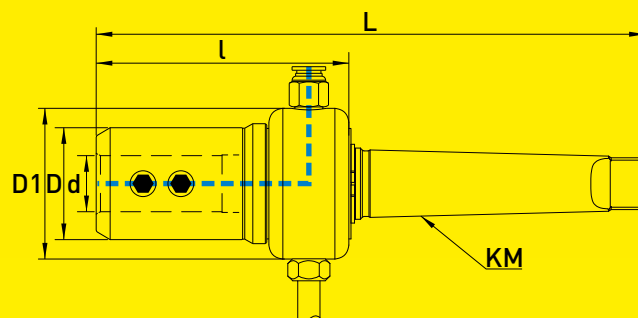

Артикул	d мм	КМ	D мм	D1 мм	l мм	L мм
ТН012.16МТ3	16	3	37	54.0	100	194.0
ТН012.16МТ4	16	4	37	63.5	110	227.5
ТН012.16МТ5	16	5	37	76.0	105	254.0
ТН012.20МТ3	20	3	40	54.0	103	197.5
ТН012.20МТ4	20	4	40	63.5	113	230.5
ТН012.20МТ5	20	5	40	76.0	108	257.0
ТН012.25МТ3	25	3	49	54.0	109	204.0
ТН012.25МТ4	25	4	49	63.5	119	236.5
ТН012.25МТ5	25	5	49	76.0	114	263.0
ТН012.32МТ4	32	4	64	76.0	128	245.5
ТН012.32МТ5	32	5	64	76.0	120	269.0
ТН012.40МТ4	40	4	73	76.0	139	256.5
ТН012.40МТ5	40	5	73	76.0	130	279.0



ИНСТРУМЕНТАЛЬНЫЙ ЗАВОД
«ВОСХОД»

РАЗДЕЛ 3. МОДУЛЬНЫЕ СИСТЕМЫ СВЕРЛЕНИЯ «ModLine», «ModLine–М»

**«ModLine»
(корпуса свёрл неразборные)...46**

**«ModLine–М»
(корпуса со сменными
сверлильными блоками).....56**

Высокопроизводительные системы сверления «ModLine» и «ModLine–М» являются отличной заменой устаревшим инструментам из быстрорежущей стали или свёрлам со сменными пластинами.

Ассортимент включает сверла диаметром от 28 до 80 мм. Этот инструмент обеспечивает существенное повышение производительности труда и эффективности вашего предприятия.



Торговая марка «ИЗ ВОСХОД» представляет модульную систему сверления «ModLine»

- конструкция системы подразумевает установку центральной твердосплавной режущей головки, благодаря которой осуществляется центрирование сверла;



- на периферии сменного блока устанавливаются сменные режущие пластины;



- стандартные сверла с глубиной сверления **от 3D до 10D** позволяют обрабатывать отверстия с большим отношением длины к диаметру, нежели системы сверления других конструкций.

**Сверла более длинных размеров
изготавливаются на заказ.**

МОДУЛЬНАЯ СИСТЕМА СВЕРЛЕНИЯ «ModLine» СО СМЕННЫМИ ГОЛОВКАМИ И ПЛАСТИНАМИ

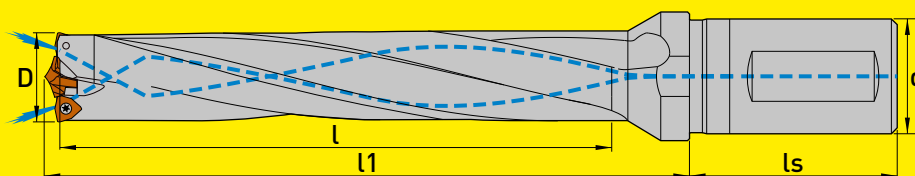

Д мм	Артикул	Глубина сверления	L мм	L1 мм	Ls мм	d h6 мм	Головки	Ключ головки	Пластины	Винт	Ключ винта
28.00	FDM280003B32	3D	84	118	60	32	FHMRA-1400	KF01	FD0108MT-040308	M2.5x8	T9
	FDM280005B32	5D	140	174							
	FDM280006B32	6D	168	202							
	FDM280007B32	7D	196	230							
	FDM280008B32	8D	224	258							
	FDM280010B32	10D	280	314							
28.58	FDM285803B32	3D	86	120	60	32	FHMRA-1500	KF01	FD0108MT-040308	M2.5x8	T9
	FDM285805B32	5D	143	177							
	FDM285806B32	6D	172	206							
	FDM285807B32	7D	201	235							
	FDM285808B32	8D	229	263							
	FDM285810B32	10D	286	320							
29.00	FDM290003B32	3D	87	121	60	32	FHMRA-1600	KF01	FD0108MT-040308	M2.5x8	T9
	FDM290005B32	5D	145	179							
	FDM290006B32	6D	174	208							
	FDM290007B32	7D	203	237							
	FDM290008B32	8D	232	266							
	FDM290010B32	10D	290	324							
29.36	FDM293603B32	3D	89	123	60	32	FHMRA-1600	KF01	FD0108MT-040308	M2.5x8	T9
	FDM293605B32	5D	147	181							
	FDM293606B32	6D	177	211							
	FDM293607B32	7D	206	240							
	FDM293608B32	8D	235	269							
	FDM293610B32	10D	294	328							
30.00	FDM300003B32	3D	90	125	60	32	FHMRA-1600	KF01	FD0108MT-040308	M2.5x8	T9
	FDM300005B32	5D	150	185							
	FDM300006B32	6D	180	215							
	FDM300007B32	7D	210	245							
	FDM300008B32	8D	240	275							
	FDM300010B32	10D	300	335							
30.18	FDM301803B32	3D	91	126	60	32	FHMRA-1800	KF02	FD0108MT-040308	M2.5x8	T9
	FDM301805B32	5D	151	186							
	FDM301806B32	6D	182	217							
	FDM301807B32	7D	212	247							
	FDM301808B32	8D	242	277							
	FDM301810B32	10D	302	337							
30.96	FDM309603B32	3D	93	128	60	32	FHMRA-1800	KF02	FD0108MT-040308	M2.5x8	T9
	FDM309605B32	5D	155	190							
	FDM309606B32	6D	186	221							
	FDM309607B32	7D	217	252							
	FDM309608B32	8D	248	283							
	FDM309610B32	10D	310	345							
31.00	FDM310003B32	3D	94	129	60	32	FHMRA-1800	KF02	FD0108MT-040308	M2.5x8	T9
	FDM310005B32	5D	156	191							
	FDM310006B32	6D	187	222							
	FDM310007B32	7D	218	253							
	FDM310008B32	8D	249	284							
	FDM310010B32	10D	311	346							

МОДУЛЬНАЯ СИСТЕМА СВЕРЛЕНИЯ «ModLine» СО СМЕННЫМИ ГОЛОВКАМИ И ПЛАСТИНАМИ

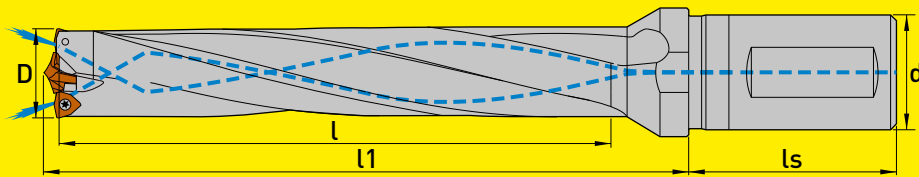

ПРОДОЛЖЕНИЕ ТАБЛИЦЫ

D мм	Артикул	Глубина сверления	l мм	l1 мм	ls мм	d h6 мм	Головки	Ключ головки	Пластины	Винт	Ключ винта
31.75	FDM317503B32	3D	96	133	60	32	FHMRA-1500	KF01	FD1608MT-080308	M3x8	T10
	FDM317505B32	5D	159	196							
	FDM317506B32	6D	191	228							
	FDM317507B32	7D	223	260							
	FDM317508B32	8D	254	291							
	FDM317510B32	10D	318	355							
32.00	FDM320003B32	3D	97	134	60	32	FHMRA-1500	KF01	FD1608MT-080308	M3x8	T10
	FDM320005B32	5D	160	197							
	FDM320006B32	6D	192	229							
	FDM320007B32	7D	224	261							
	FDM320008B32	8D	256	293							
	FDM320010B32	10D	320	357							
33.00	FDM330003B32	3D	99	136	60	32	FHMRA-1600	KF01	FD1608MT-080308	M3x8	T10
	FDM330005B32	5D	165	202							
	FDM330006B32	6D	198	235							
	FDM330007B32	7D	231	268							
	FDM330008B32	8D	264	301							
	FDM330010B32	10D	330	367							
33.20	FDM332003B32	3D	100	137	60	32	FHMRA-1600	KF01	FD1608MT-080308	M3x8	T10
	FDM332005B32	5D	166	203							
	FDM332006B32	6D	200	237							
	FDM332007B32	7D	233	270							
	FDM332008B32	8D	266	303							
	FDM332010B32	10D	332	369							
33.35	FDM333503B32	3D	101	138	60	32	FHMRA-1600	KF01	FD1608MT-080308	M3x8	T10
	FDM333505B32	5D	167	204							
	FDM333506B32	6D	201	238							
	FDM333507B32	7D	234	271							
	FDM333508B32	8D	267	304							
	FDM333510B32	10D	334	371							
34.00	FDM340003B32	3D	102	139	60	32	FHMRA-1800	KF01	FD1608MT-080308	M3x8	T10
	FDM340005B32	5D	170	207							
	FDM340006B32	6D	204	241							
	FDM340007B32	7D	238	275							
	FDM340008B32	8D	272	309							
	FDM340010B32	10D	340	377							
34.93	FDM349303B32	3D	105	142	60	32	FHMRA-1800	KF02	FD1608MT-080308	M3x8	T10
	FDM349305B32	5D	175	212							
	FDM349306B32	6D	210	247							
	FDM349307B32	7D	245	282							
	FDM349308B32	8D	280	317							
	FDM349310B32	10D	350	387							
35.00	FDM350003B32	3D	106	144	60	32	FHMRA-1800	KF02	FD1608MT-080308	M3x8	T10
	FDM350005B32	5D	176	214							
	FDM350006B32	6D	211	249							
	FDM350007B32	7D	246	284							
	FDM350008B32	8D	281	319							
	FDM350010B32	10D	350	388							

МОДУЛЬНАЯ СИСТЕМА СВЕРЛЕНИЯ «ModLine» СО СМЕННЫМИ ГОЛОВКАМИ И ПЛАСТИНАМИ

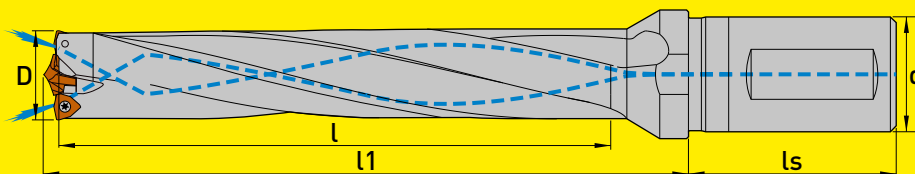

ПРОДОЛЖЕНИЕ ТАБЛИЦЫ

Ø мм	Артикул	Глубина сверления	l мм	l1 мм	ls мм	d h6 мм	Головки	Ключ головки	Пластины	Винт	Ключ винта
36.00	FDM360003B32	3D	108	146	60	32	FHMRA-1800	KF02	FD1608MT-080308	M3x8	T10
	FDM360005B32	5D	180	218							
	FDM360006B32	6D	216	254							
	FDM360007B32	7D	252	290							
	FDM360008B32	8D	288	326							
	FDM360010B32	10D	360	398							
36.53	FDM365303B32	3D	110	148	60	32	FHMRA-1900	KF02	FD1608MT-080308	M3x8	T10
	FDM365305B32	5D	183	221							
	FDM365306B32	6D	220	258							
	FDM365307B32	7D	256	294							
	FDM365308B32	8D	293	331							
	FDM365310B32	10D	366	404							
37.00	FDM370003B32	3D	111	149	60	32	FHMRA-1600	KF01	FD1608MT-100308	M4x10	T15
	FDM370005B32	5D	185	223							
	FDM370006B32	6D	222	260							
	FDM370007B32	7D	259	297							
	FDM370008B32	8D	296	334							
	FDM370010B32	10D	370	408							
37.50	FDM375003B32	3D	113	151	60	32	FHMRA-1600	KF01	FD1608MT-100308	M4x10	T15
	FDM375005B32	5D	188	226							
	FDM375006B32	6D	225	263							
	FDM375007B32	7D	263	301							
	FDM375008B32	8D	300	338							
	FDM375010B32	10D	375	413							
38.00	FDM380003B32	3D	114	154	60	32	FHMRA-1600	KF01	FD1608MT-100308	M4x10	T15
	FDM380005B32	5D	190	230							
	FDM380006B32	6D	228	268							
	FDM380007B32	7D	266	306							
	FDM380008B32	8D	304	344							
	FDM380010B32	10D	380	420							
38.10	FDM381003B32	3D	115	155	60	32	FHMRA-1600	KF01	FD1608MT-100308	M4x10	T15
	FDM381005B32	5D	191	231							
	FDM381006B32	6D	229	269							
	FDM381007B32	7D	267	307							
	FDM381008B32	8D	305	345							
	FDM381010B32	10D	381	421							
39.00	FDM390003B32	3D	117	157	60	32	FHMRA-1800	KF02	FD1608MT-100308	M4x10	T15
	FDM390005B32	5D	195	235							
	FDM390006B32	6D	234	274							
	FDM390007B32	7D	273	313							
	FDM390008B32	8D	312	352							
	FDM390010B32	10D	390	430							
39.20	FDM392003B32	3D	118	158	60	32	FHMRA-1800	KF02	FD1608MT-100308	M4x10	T15
	FDM392005B32	5D	196	236							
	FDM392006B32	6D	236	276							
	FDM392007B32	7D	275	315							
	FDM392008B32	8D	314	354							
	FDM392010B32	10D	392	432							

МОДУЛЬНАЯ СИСТЕМА СВЕРЛЕНИЯ «ModLine» СО СМЕННЫМИ ГОЛОВКАМИ И ПЛАСТИНАМИ

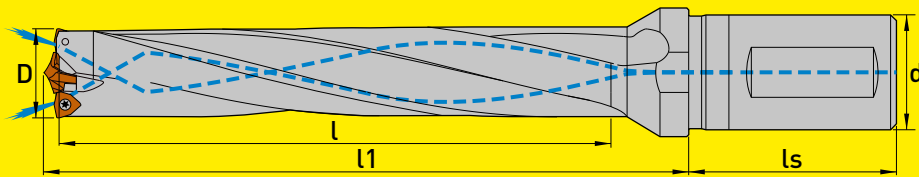

ПРОДОЛЖЕНИЕ ТАБЛИЦЫ

D мм	Артикул	Глубина сверления	l мм	l1 мм	ls мм	d h6 мм	Головки	Ключ головки	Пластины	Винт	Ключ винта
39.70	FDM397003B32	3D	120	160	60	32	FHMRA-1800	KF02	FD1608MT-100308	M4x10	T15
	FDM397005B32	5D	199	239							
	FDM397006B32	6D	239	279							
	FDM397007B32	7D	278	318							
	FDM397008B32	8D	318	358							
	FDM397010B32	10D	397	437							
40.00	FDM400003B32	3D	121	164	60	32	FHMRA-1800	KF02	FD1608MT-100308	M4x10	T15
	FDM400005B32	5D	200	243							
	FDM400006B32	6D	240	283							
	FDM400007B32	7D	280	323							
	FDM400008B32	8D	320	363							
	FDM400010B32	10D	400	443							
41.00	FDM410003B32	3D	123	166	60	32	FHMRA-1900	KF02	FD1608MT-100308	M4x10	T15
	FDM410005B32	5D	205	248							
	FDM410006B32	6D	246	289							
	FDM410007B32	7D	287	330							
	FDM410008B32	8D	328	371							
	FDM410010B32	10D	410	453							
41.28	FDM412803B32	3D	124	167	60	32	FHMRA-1900	KF02	FD1608MT-100308	M4x10	T15
	FDM412805B32	5D	207	250							
	FDM412806B32	6D	248	291							
	FDM412807B32	7D	289	332							
	FDM412808B32	8D	331	374							
	FDM412810B32	10D	413	456							
42.00	FDM420003B50	3D	126	170	80	50	FHMRA-1900	KF02	FD1608MT-120408	M4x10	T15
	FDM420005B50	5D	210	254							
	FDM420006B50	6D	252	296							
	FDM420007B50	7D	294	338							
	FDM420008B50	8D	336	380							
	FDM420010B50	10D	420	464							
43.00	FDM430003B50	3D	129	173	80	50	FHMRA-1600	KF01	FD1608MT-120408	M4x10	T15
	FDM430005B50	5D	215	259							
	FDM430006B50	6D	258	302							
	FDM430007B50	7D	301	345							
	FDM430008B50	8D	344	388							
	FDM430010B50	10D	430	474							
44.00	FDM440003B50	3D	132	176	80	50	FHMRA-1800	KF02	FD1608MT-120408	M4x10	T15
	FDM440005B50	5D	220	264							
	FDM440006B50	6D	264	308							
	FDM440007B50	7D	308	352							
	FDM440008B50	8D	352	396							
	FDM440010B50	10D	440	484							
44.45	FDM444503B50	3D	134	178	80	50	FHMRA-1800	KF02	FD1608MT-120408	M4x10	T15
	FDM444505B50	5D	223	267							
	FDM444506B50	6D	267	311							
	FDM444507B50	7D	312	356							
	FDM444508B50	8D	356	400							
	FDM444510B50	10D	445	489							

МОДУЛЬНАЯ СИСТЕМА СВЕРЛЕНИЯ «ModLine» СО СМЕННЫМИ ГОЛОВКАМИ И ПЛАСТИНАМИ

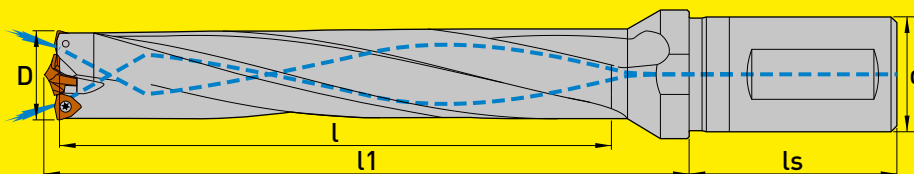

ПРОДОЛЖЕНИЕ ТАБЛИЦЫ

Д мм	Артикул	Глубина сверления	l мм	l1 мм	ls мм	d h6 мм	Головки	Ключ головки	Пластины	Винт	Ключ винта
45.00	FDM450003B50	3D	135	179	80	50	FHMRA-1800	KF02	FD1608MT-120408	M4x10	T15
	FDM450005B50	5D	225	269							
	FDM450006B50	6D	270	314							
	FDM450007B50	7D	315	359							
	FDM450008B50	8D	360	404							
	FDM450010B50	10D	450	494							
46.00	FDM460003B50	3D	138	182	80	50	FHMRA-1900	KF02	FD1608MT-120408	M4x10	T15
	FDM460005B50	5D	230	274							
	FDM460006B50	6D	276	320							
	FDM460007B50	7D	322	366							
	FDM460008B50	8D	368	412							
	FDM460010B50	10D	460	504							
47.00	FDM470003B50	3D	141	185	80	50	FHMRA-2000	KF02	FD1608MT-120408	M4x10	T15
	FDM470005B50	5D	235	279							
	FDM470006B50	6D	282	326							
	FDM470007B50	7D	329	373							
	FDM470008B50	8D	376	420							
	FDM470010B50	10D	470	514							
47.63	FDM476303B50	3D	143	187	80	50	FHMRA-2100	KF04	FD1608MT-120408	M4x10	T15
	FDM476305B50	5D	239	283							
	FDM476306B50	6D	286	330							
	FDM476307B50	7D	334	378							
	FDM476308B50	8D	382	426							
	FDM476310B50	10D	477	521							
48.00	FDM480003B50	3D	144	189	80	50	FHMRA-2100	KF04	FD1608MT-120408	M4x10	T15
	FDM480005B50	5D	240	285							
	FDM480006B50	6D	288	333							
	FDM480007B50	7D	336	381							
	FDM480008B50	8D	384	429							
	FDM480010B50	10D	480	525							
49.00	FDM490003B50	3D	147	192	80	50	FHMRA-2200	KF04	FD1608MT-120408	M4x10	T15
	FDM490005B50	5D	245	290							
	FDM490006B50	6D	294	339							
	FDM490007B50	7D	343	388							
	FDM490008B50	8D	392	437							
	FDM490010B50	10D	490	535							
50.00	FDM500003B50	3D	150	195	80	50	FHMRA-2300	KF04	FD1608MT-120408	M4x10	T15
	FDM500005B50	5D	250	295							
	FDM500006B50	6D	300	345							
	FDM500007B50	7D	350	395							
	FDM500008B50	8D	400	445							
	FDM500010B50	10D	500	545							
50.80	FDM508003B50	3D	153	198	80	50	FHMRA-2400	KF04	FD1608MT-120408	M4x10	T15
	FDM508005B50	5D	254	299							
	FDM508006B50	6D	305	350							
	FDM508007B50	7D	356	401							
	FDM508008B50	8D	407	452							
	FDM508010B50	10D	508	553							

МОДУЛЬНАЯ СИСТЕМА СВЕРЛЕНИЯ «ModLine» СО СМЕННЫМИ ГОЛОВКАМИ И ПЛАСТИНАМИ

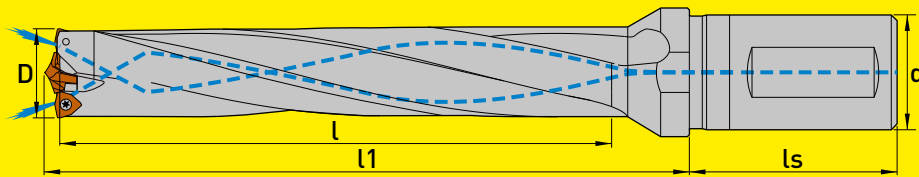

ПРОДОЛЖЕНИЕ ТАБЛИЦЫ

D мм	Артикул	Глубина сверления	l мм	l1 мм	ls мм	d h6 мм	Головки	Ключ головки	Пластины	Винт	Ключ винта
51.00	FDM510003B50	3D	154	199	80	50	FHMRA-2400	KF04	FD1608MT-120408	M4x10	T15
	FDM510005B50	5D	255	300							
	FDM510006B50	6D	306	351							
	FDM510007B50	7D	357	402							
	FDM510008B50	8D	408	453							
	FDM510010B50	10D	510	555							
52.00	FDM520003B50	3D	156	201	80	50	FHMRA-2500	KF04	FD1608MT-120408	M4x10	T15
	FDM520005B50	5D	260	305							
	FDM520006B50	6D	312	357							
	FDM520007B50	7D	364	409							
	FDM520008B50	8D	416	461							
	FDM520010B50	10D	520	565							
53.00	FDM530003B50	3D	159	204	80	50	FHMRA-2600	KF04	FD1608MT-120408	M4x10	T15
	FDM530005B50	5D	265	310							
	FDM530006B50	6D	318	363							
	FDM530007B50	7D	371	416							
	FDM530008B50	8D	424	469							
	FDM530010B50	10D	530	575							
53.98	FDM539803B50	3D	162	207	80	50	FHMRA-2700	KF04	FD1608MT-120408	M4x10	T15
	FDM539805B50	5D	270	315							
	FDM539806B50	6D	324	369							
	FDM539807B50	7D	378	423							
	FDM539808B50	8D	432	477							
	FDM539810B50	10D	540	585							
54.00	FDM540003B50	3D	163	208	80	50	FHMRA-2700	KF04	FD1608MT-120408	M4x10	T15
	FDM540005B50	5D	271	316							
	FDM540006B50	6D	325	370							
	FDM540007B50	7D	349	424							
	FDM540008B50	8D	433	478							
	FDM540010B50	10D	541	586							
55.00	FDM550003B50	3D	165	210	80	50	FHMRA-2800	KF04	FD1608MT-120408	M4x10	T15
	FDM550005B50	5D	275	320							
	FDM550006B50	6D	330	375							
	FDM550007B50	7D	385	430							
	FDM550008B50	8D	440	485							
	FDM550010B50	10D	550	595							
56.00	FDM560003B50	3D	168	213	80	50	FHMRA-2000	KF03	FD1608MT-150308	M5x10	T20
	FDM560005B50	5D	280	325							
	FDM560006B50	6D	336	381							
	FDM560007B50	7D	392	437							
	FDM560008B50	8D	448	493							
	FDM560010B50	10D	560	605							
57.00	FDM570003B50	3D	171	216	80	50	FHMRA-2100	KF03	FD1608MT-150308	M5x10	T20
	FDM570005B50	5D	285	330							
	FDM570006B50	6D	342	387							
	FDM570007B50	7D	399	444							
	FDM570008B50	8D	456	501							
	FDM570010B50	10D	570	615							

МОДУЛЬНАЯ СИСТЕМА СВЕРЛЕНИЯ «ModLine» СО СМЕННЫМИ ГОЛОВКАМИ И ПЛАСТИНАМИ

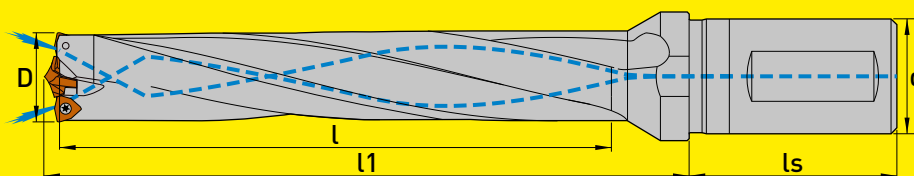

ПРОДОЛЖЕНИЕ ТАБЛИЦЫ

Д мм	Артикул	Глубина сверления	l мм	l1 мм	ls мм	d h6 мм	Головки	Ключ головки	Пластины (см. стр.)	Винт	Ключ винта
58	FDM580003B50	3D	174	219	80	50	FHMRA-2200	KF03	FD1608MT-150308	M5x10	T20
	FDM580005B50	5D	290	335							
	FDM580006B50	6D	348	393							
	FDM580007B50	7D	406	451							
	FDM580008B50	8D	464	509							
	FDM580010B50	10D	580	625							
59	FDM590003B50	3D	177	222	80	50	FHMRA-2300	KF03	FD1608MT-150308	M5x10	T20
	FDM590005B50	5D	295	340							
	FDM590006B50	6D	354	399							
	FDM590007B50	7D	413	458							
	FDM590008B50	8D	472	517							
	FDM590010B50	10D	590	635							
60	FDM600003B50	3D	180	225	80	50	FHMRA-2400	KF03	FD1608MT-150308	M5x10	T20
	FDM600005B50	5D	300	345							
	FDM600006B50	6D	360	405							
	FDM600007B50	7D	420	465							
	FDM600008B50	8D	480	525							
	FDM600010B50	10D	600	645							
61	FDM610003B50	3D	183	228	80	50	FHMRA-2500	KF03	FD1608MT-150308	M5x10	T20
	FDM610005B50	5D	305	350							
	FDM610006B50	6D	366	411							
	FDM610007B50	7D	427	472							
	FDM610008B50	8D	488	533							
	FDM610010B50	10D	610	655							
62	FDM620003B50	3D	186	231	80	50	FHMRA-2600	KF03	FD1608MT-150308	M5x10	T20
	FDM620005B50	5D	310	355							
	FDM620006B50	6D	372	417							
	FDM620007B50	7D	434	479							
	FDM620008B50	8D	496	541							
	FDM620010B50	10D	620	665							
63	FDM630003B50	3D	189	234	80	50	FHMRA-2700	KF05	FD1608MT-150308	M5x10	T20
	FDM630005B50	5D	315	360							
	FDM630006B50	6D	378	423							
	FDM630007B50	7D	441	486							
	FDM630008B50	8D	504	549							
	FDM630010B50	10D	630	675							
64	FDM640003B50	3D	192	237	80	50	FHMRA-2800	KF05	FD1608MT-150308	M5x10	T20
	FDM640005B50	5D	320	365							
	FDM640006B50	6D	384	429							
	FDM640007B50	7D	448	493							
	FDM640008B50	8D	512	557							
	FDM640010B50	10D	640	685							
65	FDM650003B50	3D	195	240	80	50	FHLRA-2900	KF05	FD1608MT-150308	M5x10	T20
	FDM650005B50	5D	325	370							
	FDM650006B50	6D	390	435							
	FDM650007B50	7D	455	500							
	FDM650008B50	8D	520	565							
	FDM650010B50	10D	650	695							

МОДУЛЬНАЯ СИСТЕМА СВЕРЛЕНИЯ «ModLine» СО СМЕННЫМИ ГОЛОВКАМИ И ПЛАСТИНАМИ

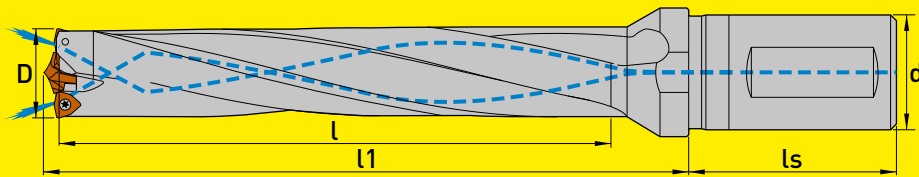

ПРОДОЛЖЕНИЕ ТАБЛИЦЫ

D мм	Артикул	Глубина сверления	l мм	l1 мм	ls мм	d h6 мм	Головки	Ключ головки	Пластины	Винт	Ключ винта
66	FDM660003B50	3D	198	243	80	50	FHLRA-3000	KF05	FD1608MT-150308	M5x10	T20
	FDM660005B50	5D	330	375							
	FDM660006B50	6D	396	441							
	FDM660007B50	7D	462	507							
	FDM660008B50	8D	528	573							
	FDM660010B50	10D	660	705							
67	FDM670003B50	3D	201	246	80	50	FHLRA-3100	KF05	FD1608MT-150308	M5x10	T20
	FDM670005B50	5D	335	380							
	FDM670006B50	6D	402	447							
	FDM670007B50	7D	469	514							
	FDM670008B50	8D	536	581							
	FDM670010B50	10D	670	715							
68	FDM680003B50	3D	204	249	80	50	FHLRA-3200	KF05	FD1608MT-150308	M5x10	T20
	FDM680005B50	5D	340	385							
	FDM680006B50	6D	408	453							
	FDM680007B50	7D	476	521							
	FDM680008B50	8D	544	589							
	FDM680010B50	10D	680	725							
69	FDM690003B50	3D	207	252	80	50	FHLRA-3300	KF06	FD1608MT-150308	M5x10	T20
	FDM690005B50	5D	345	390							
	FDM690006B50	6D	414	459							
	FDM690007B50	7D	483	528							
	FDM690008B50	8D	552	597							
	FDM690010B50	10D	690	735							
70	FDM700003B50	3D	210	255	80	50	FHLRA-3400	KF06	FD1608MT-150308	M5x10	T20
	FDM700005B50	5D	350	395							
	FDM700006B50	6D	420	465							
	FDM700007B50	7D	490	535							
	FDM700008B50	8D	560	605							
	FDM700010B50	10D	700	745							
71	FDM710003B50	3D	213	292	80	50	FHLRA-3500	KF06	FD1608MT-150308	M5x10	T20
	FDM710005B50	5D	355	434							
	FDM710006B50	6D	426	505							
	FDM710007B50	7D	497	576							
	FDM710008B50	8D	568	647							
	FDM710010B50	10D	710	789							
72	FDM720003B50	3D	216	296	80	50	FHLRA-3600	KF06	FD1608MT-150308	M5x10	T20
	FDM720005B50	5D	360	440							
	FDM720006B50	6D	432	512							
	FDM720007B50	7D	504	584							
	FDM720008B50	8D	576	656							
	FDM720010B50	10D	720	800							
73	FDM730003B50	3D	219	300	80	50	FHLRA-3700	KF06	FD1608MT-150308	M5x10	T20
	FDM730005B50	5D	365	446							
	FDM730006B50	6D	438	519							
	FDM730007B50	7D	511	592							
	FDM730008B50	8D	584	673							
	FDM730010B50	10D	730	811							

МОДУЛЬНАЯ СИСТЕМА СВЕРЛЕНИЯ «ModLine» СО СМЕННЫМИ ГОЛОВКАМИ И ПЛАСТИНАМИ

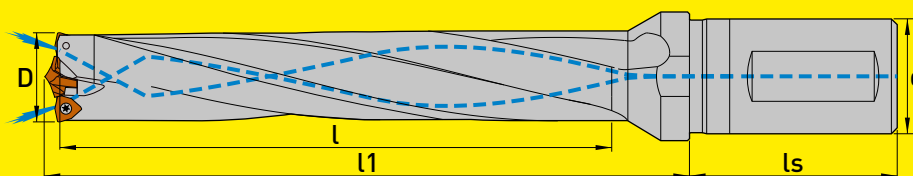

ОКОНЧАНИЕ ТАБЛИЦЫ

Д мм	Артикул	Глубина сверления	l мм	l1 мм	ls мм	d h6 мм	Головки	Ключ головки	Пластины	Винт	Ключ винта
74	FDM740003B50	3D	222	304	80	50	FHLRA-3800	KF06	FD1608MT-150308	M5x10	T20
	FDM740005B50	5D	370	452							
	FDM740006B50	6D	444	526							
	FDM740007B50	7D	518	600							
	FDM740008B50	8D	592	682							
	FDM740010B50	10D	740	822							
75	FDM750003B50	3D	225	308	80	50	FHLRA-3900	KF07	FD1608MT-150308	M5x10	T20
	FDM750005B50	5D	375	458							
	FDM750006B50	6D	450	533							
	FDM750007B50	7D	525	608							
	FDM750008B50	8D	600	691							
	FDM750010B50	10D	750	833							
76	FDM760003B50	3D	228	312	80	50	FHLRA-4000	KF07	FD1608MT-150308	M5x10	T20
	FDM760005B50	5D	380	464							
	FDM760006B50	6D	456	540							
	FDM760007B50	7D	532	616							
	FDM760008B50	8D	608	670							
	FDM760010B50	10D	760	844							
77	FDM770003B50	3D	231	316	80	50	FHLRA-4100	KF07	FD1608MT-150308	M5x10	T20
	FDM770005B50	5D	385	470							
	FDM770006B50	6D	462	547							
	FDM770007B50	7D	539	624							
	FDM770008B50	8D	616	679							
	FDM770010B50	10D	770	855							
78	FDM780003B50	3D	234	320	80	50	FHLRA-4200	KF07	FD1608MT-150308	M5x10	T20
	FDM780005B50	5D	390	476							
	FDM780006B50	6D	468	554							
	FDM780007B50	7D	546	632							
	FDM780008B50	8D	624	688							
	FDM780010B50	10D	780	866							
79	FDM790003B50	3D	237	324	80	50	FHLRA-4300	KF07	FD1608MT-150308	M5x10	T20
	FDM790005B50	5D	395	482							
	FDM790006B50	6D	474	561							
	FDM790007B50	7D	553	640							
	FDM790008B50	8D	632	697							
	FDM790010B50	10D	н.д.	н.д.							
80	FDM800003B50	3D	240	330	80	50	FHLRA-4400	KF07	FD1608MT-150308	M5x10	T20
	FDM800005B50	5D	400	489							
	FDM800006B50	6D	480	568							
	FDM800007B50	7D	560	648							
	FDM800008B50	8D	640	706							
	FDM800010B50	10D	н.д.	н.д.							

Модульная система сверления «ModLine-M» является логическим продолжением системы «ModLine» и обладает рядом преимуществ:



$D \leq 31.00$



$D \geq 31.75$

- более универсальна, так как позволяет совмещать с корпусом сверла сменные сверлильные блоки для сверления отверстий в определенном диапазоне размеров;

.....

- более надежна и менее затратна для потребителя — при выходе из строя сменного блока требуется замена только этого блока, а не сверла в целом;

.....

МОДУЛЬНАЯ СИСТЕМА СВЕРЛЕНИЯ «ModLine-M» СО СМЕННЫМИ ГОЛОВКАМИ И ПЛАСТИНАМИ СО СМЕННЫМИ СВЕРЛИЛЬНЫМИ БЛОКАМИ

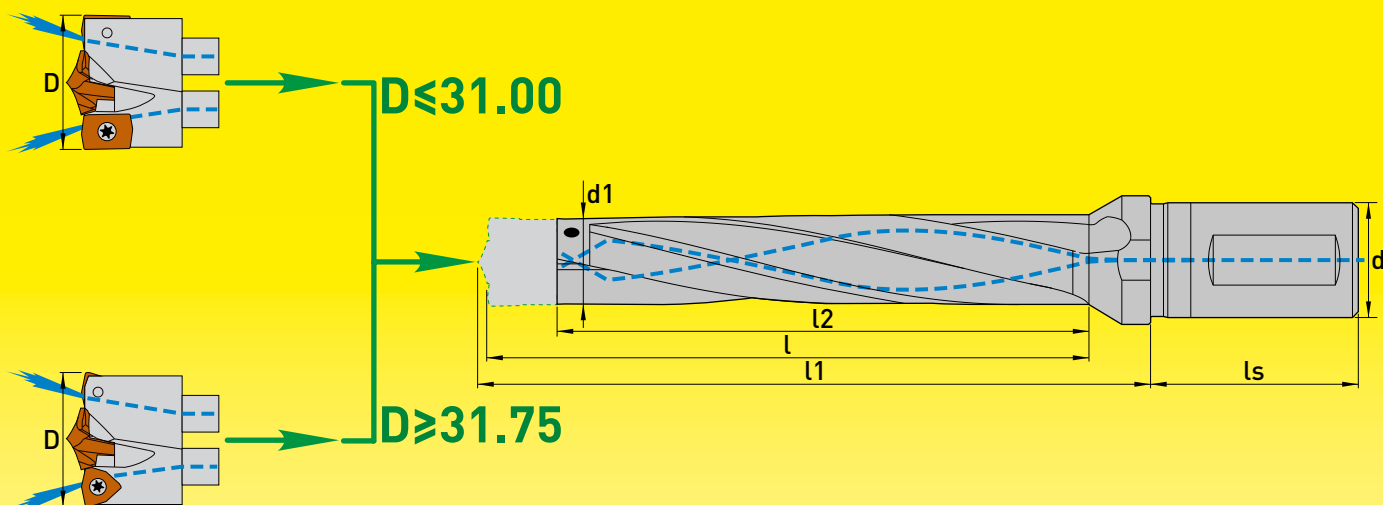

D мм	Сменные блоки	Головки	Пластины	Ключ головки	Винт	Ключ винта	Глубина сверления	Корпуса свёрл																														
								l мм	Артикул	d1 мм	d мм	l1 мм	l2 мм	ls																								
28.00	FDH2800	FHMRA-1400	FD0108MT-040308	KF01	M2.5x8	T9	3D	95	FDB28029303B32	27.00	32	134	75	60																								
28.58	FDH2858	FHMRA-1500					5D	155	FDB28029305B32						194	135																						
29.00	FDH2900	FHMRA-1600					6D	180	FDB28029306B32								220	160																				
29.36	FDH2936	FHMRA-1600					7D	215	FDB28029307B32										255	195																		
							8D	245	FDB28029308B32												285	225																
							10D	300	FDB28029310B32														340	280														
30.00	FDH3000	FHMRA-1600	FD0108MT-040308	KF01	M2.5x8	T9	3D	100	FDB30031003B32	29.00	32	138	80	60																								
30.18	FDH3018	FHMRA-1700					5D	160	FDB30031005B32						199	140																						
30.96	FDH3096	FHMRA-1700					KF02	6D	195								FDB30031006B32	233							175													
31.00	FDH3100	FHMRA-1700		7D				220	FDB30031007B32								258		200																			
				8D				250	FDB30031008B32											288	230																	
				10D			310	FDB30031010B32	348													290																
31.75	FDH3175	FHMRA-1500	FD1608MT-080308	KF01	M3.0x10	T10	3D	112		FDB31734903B32	30.75	32	148	90									60															
32.00	FDH3200	FHMRA-1500					5D	177		FDB31734905B32					212	155																						
33.00	FDH3300	FHMRA-1600					KF02	6D		211								FDB31734906B32						246	189													
33.20	FDH3320	FHMRA-1600						7D		251							FDB31734907B32	286	229																			
33.35	FDH3335	FHMRA-1600						KF01		8D							279			FDB31734908B32	314					257												
34.00	FDH3400	FHMRA-1600		KF02			10D		349	FDB31734910B32							384			327																		
34.93	FDH3493	FHMRA-1800					FD1608MT-080308		KF02	M3.0x10												T10					3D	122	FDB35037503B32	34.00	32	160	100	60				
35.00	FDH3500	FHMRA-1800																									5D	192	FDB35037505B32						230	170		
36.00	FDH3600	FHMRA-1800																									KF01	6D	227								FDB35037506B32	365
36.53	FDH3653	FHMRA-1900						KF02																				7D	272								FDB35037507B32	
37.00	FDH3700	FHMRA-1600	FD1608MT-100308	KF01	M4.0x12	T15					8D	312	FDB35037508B32	348									290															
37.50	FDH3750	FHMRA-1600									10D	382	FDB35037510B32		418	360																						
38.00	FDH3800	FHMRA-1600					FD1608MT-100308	KF01	M4.0x12	T15	3D	125	FDB38039703B32									37.00		32	165		100	60										
38.10	FDH3810	FHMRA-1600	5D	215	FDB38039705B32	245					190																											
39.00	FDH3900	FHMRA-1800	KF02	6D	255							FDB38039706B32	290					230																				
39.20	FDH3920	FHMRA-1800		7D	295			FDB38039707B32				329					270																					
39.70	FDH3970	FHMRA-1800		8D	335			FDB38039708B32						366					310																			
			10D	412	FDB38039710B32			443							387																							

МОДУЛЬНАЯ СИСТЕМА СВЕРЛЕНИЯ «ModLine-M» СО СМЕННЫМИ ГОЛОВКАМИ И ПЛАСТИНАМИ СО СМЕННЫМИ СВЕРЛИЛЬНЫМИ БЛОКАМИ

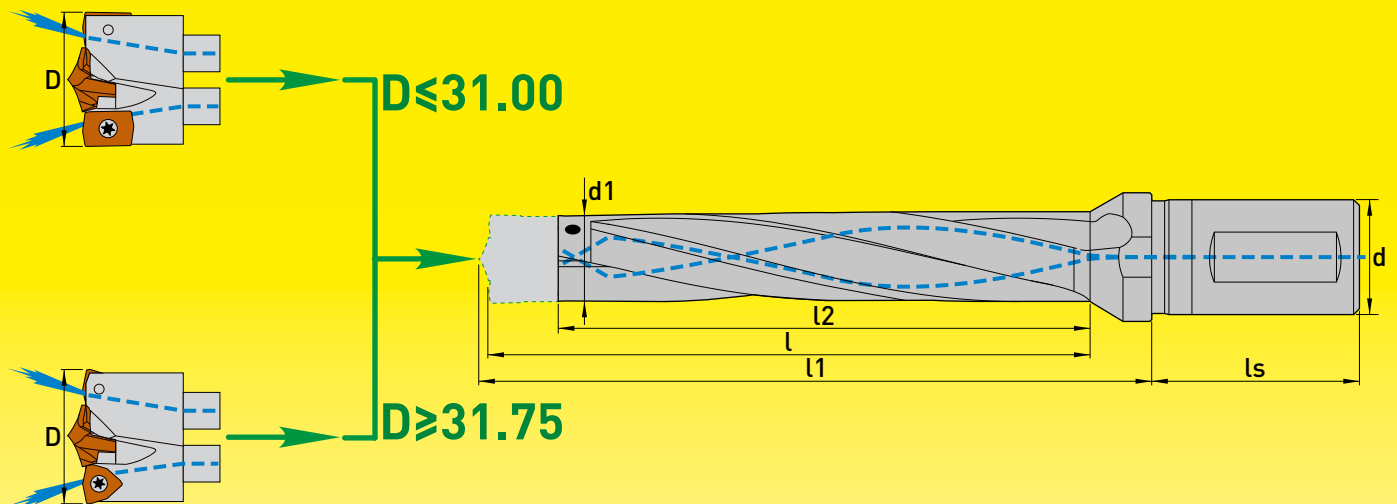

ОКОНЧАНИЕ ТАБЛИЦЫ

D мм	Сменные блоки	Головки	Пластины	Ключ головки	Винт	Ключ винта	Глубина сверления	Корпуса свёрл						
								l мм	Артикул	d1 мм	d мм	l1 мм	l2 мм	ls
40.00	FDH4000	FHMRA-1800	FD1608MT-100308	KF02	M4.0x12	T15	3D	135	FDB40041203B50	39.0	50	180	110	70
							5D	220	FDB40041205B50			265	195	
							6D	257	FDB40041206B50			305	232	
41.00	FDH4100	FHMRA-1900	FD1608MT-100308	KF02	M4.0x12	T15	7D	300	FDB40041207B50	39.0	50	343	275	70
							8D	345	FDB40041208B50			395	320	
41.28	FDH4128	FHMRA-1900	FD1608MT-100308	KF02	M4.0x12	T15	10D	425	FDB40041210B50	39.0	50	480	400	70
42.00	FDH4200	FHMRA-1900	FD1608MT-120408	KF02	M4.0x12	T15	3D	140	FDB42044403B50	41.0	50	185	115	70
							5D	230	FDB42044405B50			277	205	
							6D	275	FDB42044406B50			320	250	
43.00	FDH4300	FHMRA-1600	FD1608MT-120408	KF01	M4.0x12	T15	7D	320	FDB42044407B50	41.0	50	360	295	70
							8D	365	FDB42044408B50			405	340	
44.00	FDH4400	FHMRA-1800	FD1608MT-120408	KF02	M4.0x12	T15	10D	455	FDB42044410B50	41.0	50	500	430	70
44.45	FDH4445	FHMRA-1800	FD1608MT-120408	KF02	M4.0x12	T15	3D	150	FDB45047603B50	44.0	50	195	124	70
							5D	245	FDB45047605B50			285	219	
							6D	295	FDB45047606B50			350	269	
46.00	FDH4600	FHMRA-1900	FD1608MT-120408	KF02	M4.0x12	T15	7D	346	FDB45047607B50	44.0	50	390	320	70
							8D	390	FDB45047608B50			435	364	
47.00	FDH4700	FHMRA-2000	FD1608MT-120408	KF04	M4.0x12	T15	10D	485	FDB45047610B50	44.0	50	530	459	70
47.63	FDH4763	FHMRA-2100	FD1608MT-120408	KF04	M4.0x12	T15	3D	160	FDB48050003B50	47.0	50	200	125	70
							5D	260	FDB48050005B50			305	225	
							6D	310	FDB48050006B50			350	275	
48.00	FDH4800	FHMRA-2100	FD1608MT-120408	KF04	M4.0x12	T15	7D	360	FDB48050007B50	47.0	50	400	325	70
							8D	410	FDB48050008B50			450	375	
49.00	FDH4900	FHMRA-2200	FD1608MT-120408	KF04	M4.0x12	T15	10D	510	FDB48050010B50	47.0	50	550	475	70
50.00	FDH5000	FHMRA-2300	FD1608MT-120408	KF04	M4.0x12	T15	3D	170	FDB50853003B50	49.8	50	210	135	70
							5D	275	FDB50853005B50			315	240	
							6D	330	FDB50853006B50			370	295	
50.80	FDH5080	FHMRA-2400	FD1608MT-120408	KF04	M4.0x12	T15	7D	375	FDB50853007B50	49.8	50	415	340	70
							8D	425	FDB50853008B50			465	390	
51.00	FDH5100	FHMRA-2400	FD1608MT-120408	KF04	M4.0x12	T15	10D	530	FDB50853010B50	49.8	50	570	495	70
52.00	FDH5200	FHMRA-2500	FD1608MT-120408	KF04	M4.0x12	T15	3D	175	FDB53955003B50	53.0	50	215	140	70
							5D	280	FDB53955005B50			320	245	
							6D	340	FDB53955006B50			380	305	
53.00	FDH5300	FHMRA-2600	FD1608MT-120408	KF04	M4.0x12	T15	7D	385	FDB53955007B50	53.0	50	425	350	70
							8D	440	FDB53955008B50			480	405	
53.98	FDH5398	FHMRA-2700	FD1608MT-120408	KF04	M4.0x12	T15	10D	550	FDB53955010B50	53.0	50	590	515	70
54.00	FDH5400	FHMRA-2700	FD1608MT-120408	KF04	M4.0x12	T15	3D	175	FDB53955003B50	53.0	50	215	140	70
							5D	280	FDB53955005B50			320	245	
							6D	340	FDB53955006B50			380	305	
54.00	FDH5400	FHMRA-2700	FD1608MT-120408	KF04	M4.0x12	T15	7D	385	FDB53955007B50	53.0	50	425	350	70
							8D	440	FDB53955008B50			480	405	
55.00	FDH5500	FHMRA-2800	FD1608MT-120408	KF04	M4.0x12	T15	10D	550	FDB53955010B50	53.0	50	590	515	70

МОДУЛЬНАЯ СИСТЕМА СВЕРЛЕНИЯ «ModLine-M» СО СМЕННЫМИ ГОЛОВКАМИ И ПЛАСТИНАМИ СО СМЕННЫМИ СВЕРЛИЛЬНЫМИ БЛОКАМИ

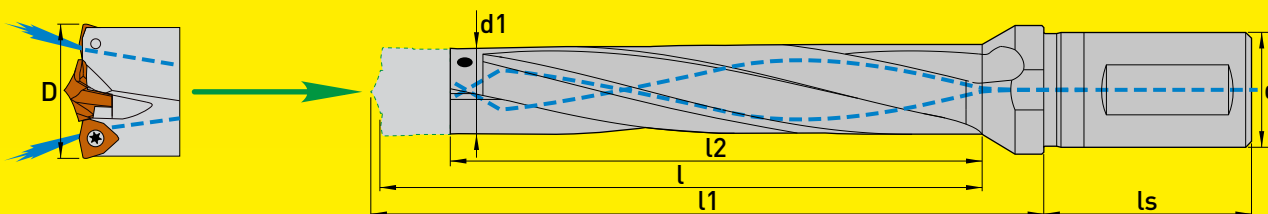

D мм	Сменные блоки	Головки	Пластины	Ключ головки	Винт	Ключ винта	Глубина сверления	Корпуса свёрл													
								l мм	Артикул	d1 мм	d мм	l1 мм	l2 мм	ls							
56	FDH5600	FHMRA-2000	FD1608MT-150308	KF03	M5x12	T20	3D	214	FDB56058003B50	53	50	237	180	80							
							5D	321	FDB56058005B50			321	287								
6D	374	FDB56058006B50					397	340													
7D	429	FDB56058007B50					452	395													
8D	499	FDB56058008B50					522	465													
10D	619	FDB56058010B50					642	585													
59	FDH5900	FHMRA-2300					FD1608MT-150308	KF03	M5x12			T20	3D		234	FDB59064003B50	58	50	262	200	80
60	FDH6000	FHMRA-2400											5D		359	FDB59064005B50			359	325	
61	FDH6100	FHMRA-2500											6D		422	FDB59064006B50			450	388	
62	FDH6200	FHMRA-2600											7D		486	FDB59064007B50			514	452	
63	FDH6300	FHMRA-2700	KF05	8D	548	FDB59064008B50				576	514										
64	FDH6400	FHMRA-2800		10D	640	FDB59064010B50				674	576										
65	FDH6500	FHLRA-2900		FD1608MT-150308	KF05	M5x12				T20	3D		250	FDB65071003B50	64	50			273	215	
66	FDH6600	FHLRA-3000	5D								385		FDB65071005B50	385					350		
67	FDH6700	FHLRA-3100	6D								431		FDB65071006B50	454					396		
68	FDH6800	FHLRA-3200	7D								525		FDB65071007B50	548					490		
69	FDH6900	FHLRA-3300	KF06				8D	595	FDB65071008B50		618	560									
70	FDH7000	FHLRA-3400					10D	745	FDB65071010B50		7687	710									
71	FDH7100	FHLRA-3500					FD1608MT-150308	KF06	M5x12		T20	3D	285	FDB72080003B50			71	50	305	245	80
72	FDH7200	FHLRA-3600	5D									445	FDB72080005B50	445					405		
73	FDH7300	FHLRA-3700	6D									485	FDB72080006B50	525					465		
74	FDH7400	FHLRA-3800	7D									605	FDB72080007B50	625					565		
75	FDH7500	FHLRA-3900	KF07	8D	685	FDB72080008B50				705		645									
76	FDH7600	FHLRA-4000		10D	845	FDB72080010B50				865		805									
77	FDH7700	FHLRA-4100																			
78	FDH7800	FHLRA-4200																			
79	FDH7900	FHLRA-4300																			
80	FDH8000	FHLRA-4400																			

СМЕННЫЕ ЭЛЕМЕНТЫ ДЛЯ СВЁРЛ СИСТЕМ «ModLine» И «ModLine-M»

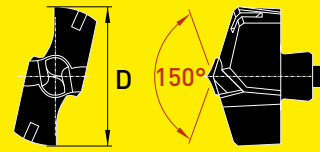
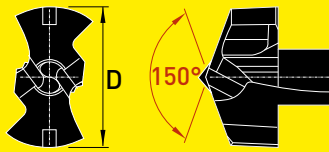

Артикул	D мм	Для свёрл с диапазонами сверления
FHMRA-1400	14	28.00
FHMRA-1500	15	28.58/31.75÷32.00
FHMRA-1600	16	29.00÷30.00/33.00÷34.00/37.50÷38.10/43.00
FHMRA-1700	17	30.18÷31.00
FHMRA-1800	18	34.93÷36.00/39.00÷40.00/44.00÷45.00
FHMRA-1900	19	41.00÷42.00/46.00
FHMRA-2000	20	47.00/56.00
FHMRA-2100	21	47.63÷48.00/57.00
FHMRA-2200	22	49.00/58.00
FHMRA-2300	23	50.00/59.00
FHMRA-2400	24	50.80÷51.00/60.00
FHMRA-2500	25	52.00/61.00
FHMRA-2600	26	53.00/62.00
FHMRA-2700	27	53.98÷54.00/63.00
FHMRA-2800	28	55.00/64.00

Артикул	D мм	Для свёрл с диапазонами сверления
FHLRA-2900	29	65
FHLRA-3000	30	66
FHLRA-3100	31	67
FHLRA-3200	32	68
FHLRA-3300	33	69
FHLRA-3400	34	70
FHLRA-3500	35	71
FHLRA-3600	36	72
FHLRA-3700	37	73
FHLRA-3800	38	74
FHLRA-3900	39	75
FHLRA-4000	40	76
FHLRA-4100	41	77
FHLRA-4200	42	78
FHLRA-4300	43	79
FHLRA-4400	44	80

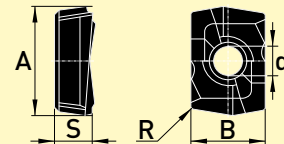
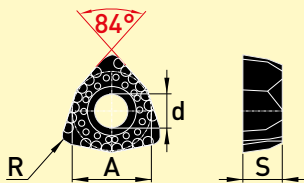

Артикул	A мм	S мм	R мм	d мм
FD1608MT-080308-23E	8	3.75	0.8	3.4
FD1608MT-100308-23E	10	3.75	0.8	4.4
FD1608MT-120408-23E	12	4.75	0.8	4.4
FD1608MT-150508-23E	15	5.25	0.8	5.5

Артикул	A мм	B мм	S мм	R мм	d мм
FD0108MT-080304	10.76	7.26	3.79	0.4	2.85

РЕКОМЕНДУЕМЫЕ РЕЖИМЫ РЕЗАНИЯ

ISO	Материалы	Состояние	Предел прочности (Н/мм ²)	Твердость	Скорость резания V _c (м/мин)	Подача (мм/об) и диаметр сверла					
						28.00–31.74	31.74–35.99	36.00–44.99	45.00–55.99	56.00–102.35	
P	Нелегированная сталь, литье, легкообрабатываемая сталь	<0.25%С	Отожженные	420	125	90–215	0.13–0.25	0.13–0.25	0.16–0.28	0.18–0.32	0.20–0.36
		≥0.25%С	Отожженные	650	190	70–170	0.16–0.28	0.16–0.28	0.20–0.32	0.20–0.40	0.20–0.45
		<0.55%С	Закалённые и отпущенные	850	250	70–170	0.16–0.28	0.16–0.28	0.20–0.32	0.20–0.40	0.20–0.45
		≥0.55%С	Отожженные	750	220	70–170	0.16–0.28	0.16–0.28	0.20–0.32	0.20–0.40	0.20–0.45
			Закалённые и отпущенные	1000	300	70–160	0.16–0.28	0.16–0.28	0.20–0.32	0.20–0.40	0.20–0.45
	Низколегированная сталь и литье (менее 5% легирующих добавок)	Отожженные		600	200	90–215	0.16–0.28	0.16–0.28	0.20–0.32	0.20–0.40	0.20–0.45
				930	275	60–160	0.16–0.28	0.16–0.28	0.20–0.32	0.20–0.40	0.20–0.45
		Закалённые и отпущенные		1000	300	60–160	0.16–0.28	0.16–0.28	0.20–0.32	0.20–0.40	0.20–0.45
				1200	350	60–160	0.16–0.28	0.16–0.28	0.20–0.32	0.20–0.40	0.20–0.45
	Высоколегированная сталь, литье и инструментальная сталь	Отожженные	680	200	70–170	0.16–0.28	0.16–0.28	0.20–0.32	0.20–0.40	0.20–0.45	
Закалённые и отпущенные		1100	325	60–160	0.16–0.28	0.16–0.28	0.20–0.32	0.20–0.40	0.20–0.45		
Нержавеющая сталь	Ферритные/Мартенситные	680	200	50–120	0.16–0.28	0.16–0.28	0.20–0.32	0.20–0.40	0.20–0.45		
M	Нержавеющая сталь и литье	Аустенитные	600	180	60–135	0.13–0.25	0.13–0.25	0.16–0.28	0.16–0.32	0.20–0.36	
		Дуплексные	820	240	40–90	0.13–0.25	0.13–0.25	0.16–0.28	0.16–0.32	0.20–0.36	
K	Серый чугун (GG)	Ферритный		160	60–160	0.18–0.30	0.18–0.30	0.216–0.360	0.24–0.42	0.30–0.48	
		Перлитный		250	60–160	0.18–0.30	0.18–0.30	0.216–0.360	0.24–0.42	0.30–0.48	
	Чугун с шаровидным графитом (GGG)	Ферритный		180	60–160	0.18–0.30	0.18–0.30	0.216–0.360	0.24–0.42	0.30–0.48	
		Перлитный		260	60–160	0.18–0.30	0.18–0.30	0.216–0.360	0.24–0.42	0.30–0.48	
	Ковкий чугун	Ферритный		130	50–150	0.18–0.30	0.18–0.30	0.216–0.360	0.24–0.42	0.30–0.48	
Перлитный			230	50–150	0.18–0.30	0.18–0.30	0.216–0.360	0.24–0.42	0.30–0.48		
N	Деформируемые алюминиевые сплавы	Неструктурированные		60	100–240	0.12–0.20	0.12–0.20	0.144–0.280	0.16–0.32	0.20–0.40	
		Структурированные		100	100–240	0.12–0.20	0.12–0.20	0.144–0.280	0.16–0.32	0.20–0.40	
	Алюминий – литье, легированный сплав	<12% Si	Неструктурированные		75	100–240	0.12–0.20	0.12–0.20	0.144–0.280	0.16–0.32	0.20–0.40
			Структурированные		90	100–240	0.12–0.20	0.12–0.20	0.144–0.280	0.16–0.32	0.20–0.40
	>12% Si	Жаропрочные сплавы		130	100–240	0.12–0.20	0.12–0.20	0.144–0.280	0.16–0.32	0.20–0.40	
	Сплавы меди	>1% Pb	Легкообрабатываемые		110	100–240	0.12–0.20	0.12–0.20	0.144–0.280	0.16–0.32	0.20–0.40
			Латунь		90	100–240	0.12–0.20	0.12–0.20	0.144–0.280	0.16–0.32	0.20–0.40
		Электролитная медь		100	100–240	0.12–0.20	0.12–0.20	0.144–0.280	0.16–0.32	0.20–0.40	
S	Жаропрочные сплавы	На основе железа	Отожженные		200	20–60	0.13–0.25	0.13–0.25	0.16–0.28	0.16–0.32	0.20–0.36
			Структурированные		280	20–60	0.13–0.25	0.13–0.25	0.16–0.28	0.16–0.32	0.20–0.36
		На основе никеля или кобальта	Отожженные		250	15–45	0.13–0.25	0.13–0.25	0.16–0.28	0.16–0.32	0.20–0.36
			Структурированные		350	15–45	0.13–0.25	0.13–0.25	0.16–0.28	0.16–0.32	0.20–0.36
	Литье			320	15–45	0.13–0.25	0.13–0.25	0.16–0.28	0.16–0.32	0.20–0.36	
Титановые сплавы			Rm 400		20–60	0.13–0.25	0.13–0.25	0.16–0.28	0.16–0.32	0.20–0.36	
		Альфа и бета сплавы структурированные	Rm 1050		15–45	0.13–0.25	0.13–0.25	0.16–0.28	0.16–0.32	0.20–0.36	

РЕКОМЕНДОВАННЫЕ ЗНАЧЕНИЯ ПАРАМЕТРОВ РЕЗАНИЯ, ПРЕДСТАВЛЕННЫЕ В ТАБЛИЦЕ, ЯВЛЯЮТСЯ ОРИЕНТИРОВОЧНЫМИ И ДОЛЖНЫ ПРИМЕНЯТЬСЯ И КОРРЕКТИРОВАТЬСЯ В ЗАВИСИМОСТИ ОТ КОНКРЕТНЫХ УСЛОВИЙ СВЕРЛЕНИЯ.



В



ИНСТРУМЕНТАЛЬНЫЙ ЗАВОД
«ВОСХОД»

AluLine

РАЗДЕЛ 4. ВЫСОКОПРОИЗВОДИТЕЛЬНЫЕ ФРЕЗЫ ДЛЯ ВЫСОКОСКОРОСТНОЙ ОБРАБОТКИ АЛЮМИНИЯ И СПЛАВОВ ЦВЕТНЫХ МЕТАЛЛОВ

*Высокопроизводительная геометрия пластин снижает силу резания.
Широкий диапазон доступных радиусов пластин от 0.4 до 5.0 мм.*

«Alu-Line-Small»

ap=10 мм.....64



«Alu-Line-General»

ap=13 мм.....66



«Alu-Line-Big»

ap=17 мм.....68



*Три типоразмера пластин позволяет оптимально
подобрать диаметр фрезы и глубину резания.*

*Уникальный дизайн пластин.
Исключительно высокая
производительность при обработке
алюминия и цветных металлов.*

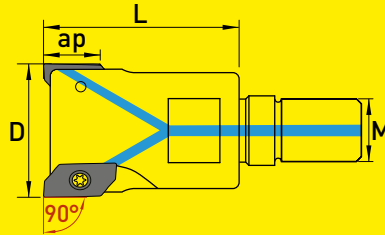

ГОЛОВКИ ФРЕЗЕРНЫЕ
С РЕЗЬБОВЫМ ХВОСТОВИКОМ
(угол в плане 90°)



Артикул	D мм	Статус	L мм	ap мм	M	Z	Каналы СОЖ	Пластины	Винт	Ключ
BM90AL15-016Z02025000M08P11-C	16	⊙	25	10	M8	2	✓	BMALGT-11X3...	B2506	T07
BM90AL15-020Z03030000M10P11-C	20	⊙	30		M10	3	✓			
BM90AL15-025Z04035000M12P11-C	25	⊙	35		M12	4	✓			
BM90AL15-032Z05043000M16P11-C	32	⊙	43		M16	5	✓			

Фрезы с другими геометрическими размерами изготавливаются по специальному заказу.

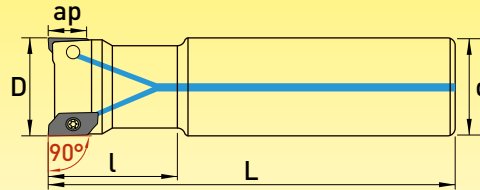

ФРЕЗЫ КОНЦЕВЫЕ
С ЦИЛИНДРИЧЕСКИМ
ХВОСТОВИКОМ
(угол в плане 90°)



Артикул	D мм	Статус	L мм	L мм	d мм	ap мм	Z	Каналы СОЖ	Пластины	Винт	Ключ
BM90AL15-016Z02032165S16P11-C	16	⊙	32	165	16	10	2	✓	BMALGT-11X3...	B2506	T07
BM90AL15-020Z03040165S20P11-C	20	⊙	40	165	20		3	✓			
BM90AL15-025Z04050225S25P11-C	25	⊙	50	225	25		4	✓			
BM90AL15-032Z05050225S32P11-C	32	⊙	50	225	32		5	✓			

Фрезы с другими геометрическими размерами изготавливаются по специальному заказу.

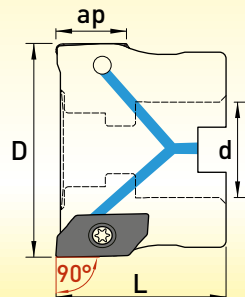

ФРЕЗЫ ТОРЦОВЫЕ НАСАДНЫЕ
(угол в плане 90°)

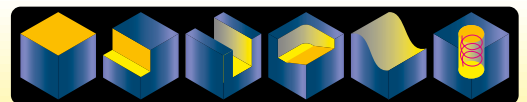

Артикул	D мм	Статус	L мм	d мм	ap мм	Z	Каналы СОЖ	Пластины	Винт	Ключ
BM90AL15-040Z05040000D16P11-C	40	⊙	40	16	10	5	✓	BMALGT-11X3...	B2506	T07
BM90AL15-050Z06040000D22P11-C	50	⊙	40	22		6	✓			

Фрезы с другими геометрическими размерами изготавливаются по специальному заказу.

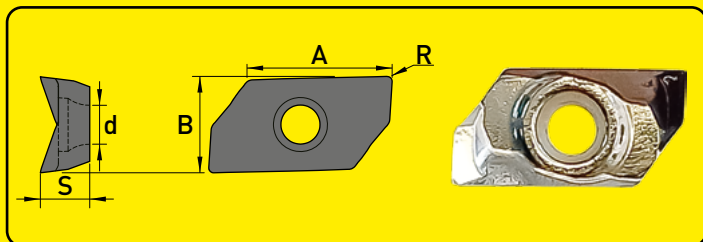

ПЛАСТИНЫ ДЛЯ ФРЕЗ: ТИП ВМ90А15

P	
M	
K	
N	★
S	
H	

СПЛАВЫ
без покрытия

Артикул	А мм	В мм	R мм	d мм	S мм	Fz мм/зуб	FN20
BMALGT-11X302FR-AL	11	6.6	0.2	2.8	3.55	0.08	⊙
BMALGT-11X304FR-AL			0.4			0.12	⊙
BMALGT-11X308FR-AL			0.8			0.14	⊙
BMALGT-11X310FR-AL			1.0			0.15	⊙
BMALGT-11X320FR-AL			2.0			0.16	⊙
BMALGT-11X330FR-AL			3.0			0.20	⊙

РЕКОМЕНДОВАННЫЕ ЗНАЧЕНИЯ ПАРАМЕТРОВ РЕЗАНИЯ, ПРЕДСТАВЛЕННЫЕ В ТАБЛИЦЕ, ЯВЛЯЮТСЯ ОРИЕНТИРОВОЧНЫМИ И ДОЛЖНЫ ПРИМЕНЯТЬСЯ И КОРРЕКТИРОВАТЬСЯ В ЗАВИСИМОСТИ ОТ КОНКРЕТНЫХ УСЛОВИЙ ОБРАБОТКИ.

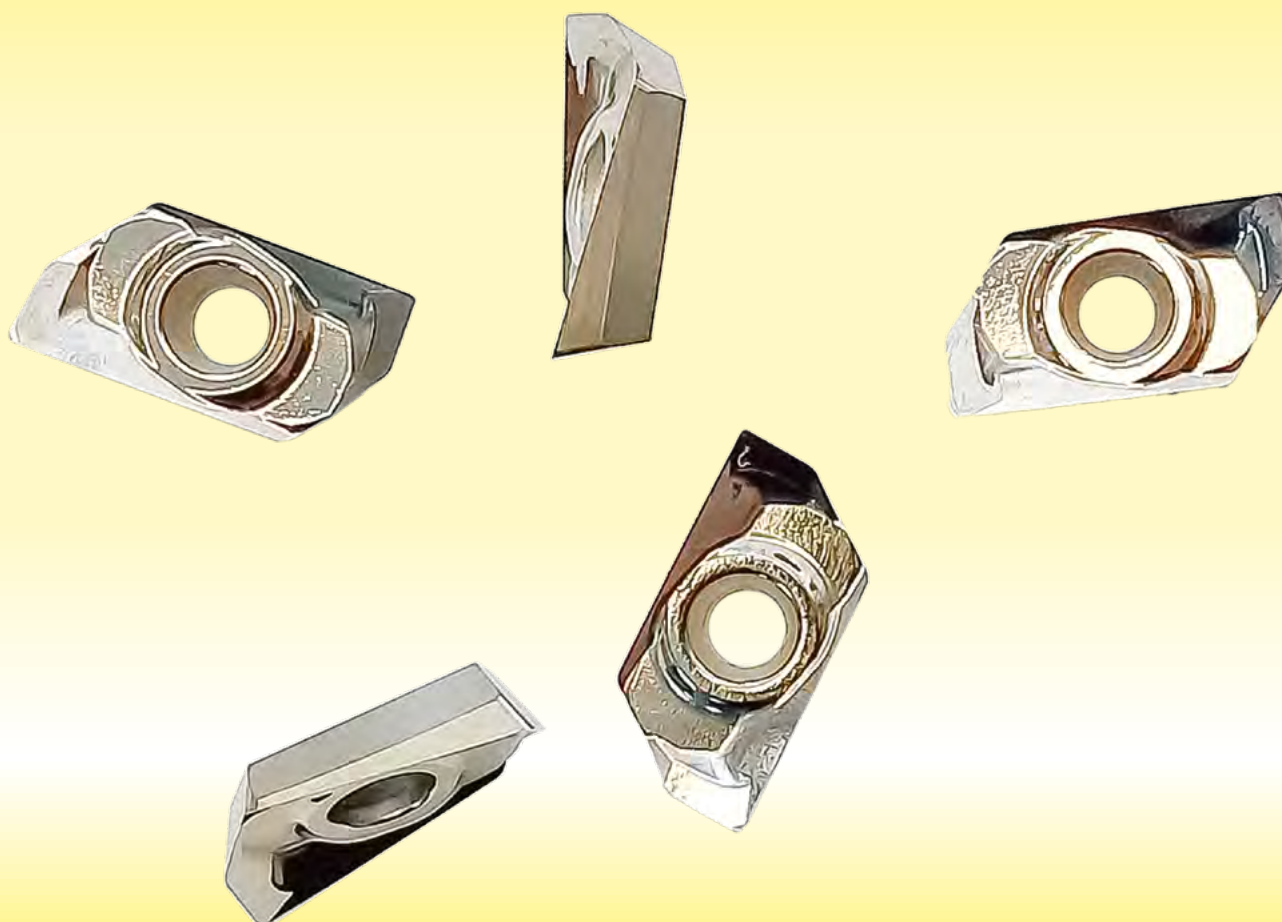

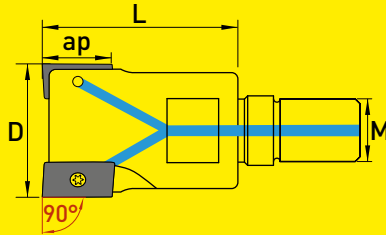
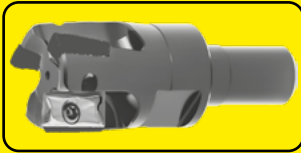

ГОЛОВКИ ФРЕЗЕРНЫЕ С РЕЗЬБОВЫМ ХВОСТОВИКОМ (угол в плане 90°)



Артикул	D мм	Статус	L мм	ap мм	M	Z	Каналы СОЖ	Пластины	Винт	Ключ
BM90AL15-025Z02045000M12P15-C	25	⊙	45	13	M12	2	✓	BMAL15GT-1504...	B3508	T15
BM90AL15-032Z02052000M16P15-C	32	⊙	52		M16	2	✓			
BM90AL15-040Z03052000M16P15-C	40	⊙	52		M16	3	✓			

Фрезы с другими геометрическими размерами изготавливаются по специальному заказу.

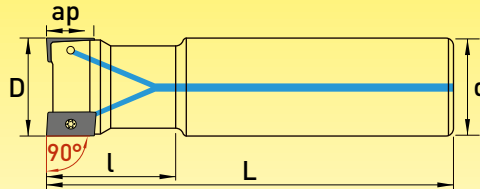
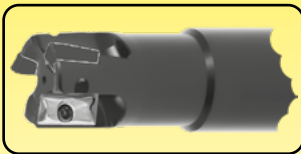

ФРЕЗЫ КОНЦЕВЫЕ С ЦИЛИНДРИЧЕСКИМ ХВОСТОВИКОМ (угол в плане 90°)



Артикул	D мм	Статус	L мм	L мм	d мм	ap мм	Z	Каналы СОЖ	Пластины	Винт	Ключ
BM90AL15-025Z02040100S25P15-C	25	⊙	40	100	25	13	2	✓	BMAL15GT-1504...	B3508	T15
BM90AL15-032Z02040110S32P15-C	32	⊙	40	110	32		2	✓			
BM90AL15-040Z03000110S32P15-C	40	⊙	40	110	32		3	✓			

Фрезы с другими геометрическими размерами изготавливаются по специальному заказу.

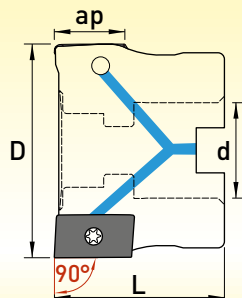
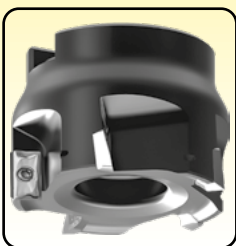

ФРЕЗЫ ТОРЦОВЫЕ НАСАДНЫЕ (угол в плане 90°)

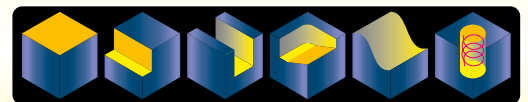

Артикул	D мм	Статус	L мм	d мм	ap мм	Z	Каналы СОЖ	Пластины	Винт	Ключ
BM90AL15-040Z04040000D16P15-C	40	⊙	40	16	13	4	✓	BMAL15GT-1504...	B3508	T15
BM90AL15-050Z05040000D22P15-C	50	⊙	40	22		5	✓			
BM90AL15-063Z06040000D22P15-C	63	⊙	40	22		6	✓			
BM90AL15-080Z07050000D27P15-C	80	⊙	50	27		7	✓			
BM90AL15-100Z08050000D32P15-C	100	⊙	50	32		8	✓			
BM90AL15-125Z10063000D40P15-C	125	⊙	63	40		10	✓			

Фрезы с другими геометрическими размерами изготавливаются по специальному заказу.

⊙ — стандартная позиция; ○ — продукция изготавливается по спецзаказу потребителя, минимальная партия и сроки — по запросу.

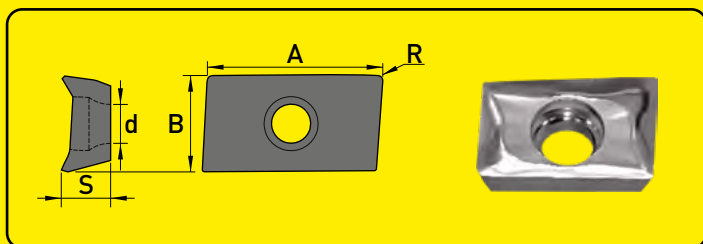

ПЛАСТИНЫ ДЛЯ ФРЕЗ: ТИП ВМ90А15

P	
M	
K	
N	★
S	
H	

Артикул	А мм	В мм	R мм	d мм	S мм	Fz мм/зуб	СПЛАВЫ
							без покрытия
							FN20
ВМА15GT-150408FR-AL	13	9.7	0.8	4.4	4.76	0.14	◎
ВМА15GT-150412FR-AL			1.2				◎

РЕКОМЕНДОВАННЫЕ ЗНАЧЕНИЯ ПАРАМЕТРОВ РЕЗАНИЯ, ПРЕДСТАВЛЕННЫЕ В ТАБЛИЦЕ, ЯВЛЯЮТСЯ ОРИЕНТИРОВОЧНЫМИ И ДОЛЖНЫ ПРИМЕНЯТЬСЯ И КОРРЕКТИРОВАТЬСЯ В ЗАВИСИМОСТИ ОТ КОНКРЕТНЫХ УСЛОВИЙ ОБРАБОТКИ.

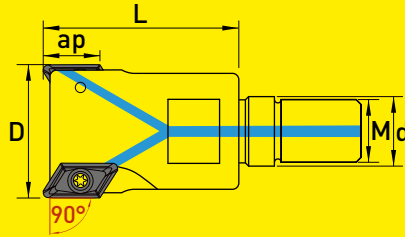
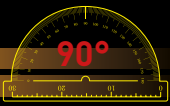

ГОЛОВКИ ФРЕЗЕРНЫЕ С РЕЗЬБОВЫМ ХВОСТОВИКОМ (угол в плане 90°)



Артикул	D мм	Статус	L мм	d мм	ap мм	M	Z	Каналы СОЖ	Пластины	Винт	Ключ
КМ90AL20-025Z02055000M12P19-C-A/B*	25	⊙	55	12.5	17	M12	2	✓	КМАЛ20FR-19X5...	VD0408	T15
КМ90AL20-032Z02055000M16P19-C-A/B*	32	⊙		17.0		M16		✓			
КМ90AL20-032Z03055000M16P19-C-A/B*	32	○		17.0		M16	✓				
КМ90AL20-040Z03055000M16P19-C-A/B*	40	⊙		17.0		M16	✓				

* ТИП А для пластин с радиусом 0.4—3.2 мм. ТИП В для пластин с радиусом 4.0—5.0 мм.

Фрезы с другими геометрическими размерами изготавливаются по специальному заказу.

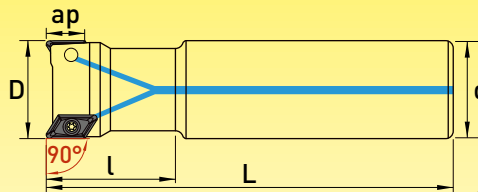

ФРЕЗЫ КОНЦЕВЫЕ С ЦИЛИНДРИЧЕСКИМ ХВОСТОВИКОМ (угол в плане 90°)



Артикул	D мм	Статус	L мм	L мм	d мм	ap мм	Z	Каналы СОЖ	Пластины	Винт	Ключ
КМ90AL20-020Z01060130S20P19-C-A/B*	20	⊙	60	130	20	17	1	✓	КМАЛ20FR-19X5...	VD0408	T15
КМ90AL20-025Z02060140S25P19-C-A/B*	25	⊙	60	140	25		2	✓			
КМ90AL20-025Z02060200S25P19-C-A/B*	25	⊙	60	200	25		2	✓			
КМ90AL20-025Z02110200S25P19-C-A/B*	25	○	110	200	25		2	✓			
КМ90AL20-032Z02070150S32P19-C-A/B*	32	⊙	70	150	32		2	✓			
КМ90AL20-032Z02070220S32P19-C-A/B*	32	⊙	70	220	32		2	✓			
КМ90AL20-032Z02110220S32P19-C-A/B*	32	○	110	220	32		2	✓			
КМ90AL20-040Z03000160S32P19-C-A/B*	40	⊙	70	160	32		3	✓			
КМ90AL20-040Z03000220S32P19-C-A/B*	40	⊙	70	220	32		3	✓			
КМ90AL20-040Z03070160S40P19-C-A/B*	40	⊙	70	160	40		3	✓			
КМ90AL20-040Z03000220S32P19-C-A/B*	40	○	110	220	32		3	✓			
КМ90AL20-040Z03070160S42P19-C-A/B*	40	⊙	70	160	42		3	✓			
КМ90AL20-040Z03000250S32P19-C-A/B*	40	○	140	250	32		3	✓			

* ТИП А для пластин с радиусом 0.4—3.2 мм. ТИП В для пластин с радиусом 4.0—5.0 мм.

Фрезы с другими геометрическими размерами изготавливаются по специальному заказу.



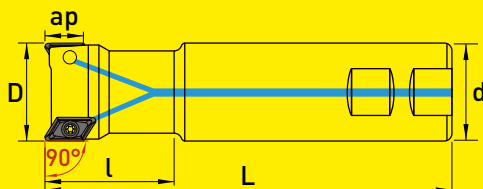

**ФРЕЗЫ КОНЦЕВЫЕ
С ХВОСТОВИКОМ WELDON
(угол в плане 90°)**



Артикул	D мм	Статус	L мм	L мм	d мм	ap мм	Z	Каналы СОЖ	Пластины	Винт	Ключ
КМ90AL20-020Z01060130W20P19-C-A/B*	20	●	60	130	20		1	✓	КМАЛ20FR-19X5...	VD0408	T15
КМ90AL20-025Z02060140W25P19-C-A/B*	25	●	60	140	25		2	✓			
КМ90AL20-025Z02060200W25P19-C-A/B*	25	●	60	200	25		2	✓			
КМ90AL20-025Z02110200W25P19-C-A/B*	25	○	110	200	25		2	✓			
КМ90AL20-032Z02070150W32P19-C-A/B*	32	●	70	150	32		2	✓			
КМ90AL20-032Z02070220W32P19-C-A/B*	32	●	70	220	32		2	✓			
КМ90AL20-032Z02110220W32P19-C-A/B*	32	○	110	220	32	17	2	✓			
КМ90AL20-040Z03000160W32P19-C-A/B*	40	●	70	160	32		3	✓			
КМ90AL20-040Z03000220W32P19-C-A/B*	40	●	70	220	32		3	✓			
КМ90AL20-040Z03070160W40P19-C-A/B*	40	●	70	160	40		3	✓			
КМ90AL20-040Z03000220W32P19-C-A/B*	40	○	110	220	32		3	✓			
КМ90AL20-040Z03070160W42P19-C-A/B*	40	●	70	160	42		3	✓			
КМ90AL20-040Z03000250W32P19-C-A/B*	40	○	140	250	32		3	✓			

* ТИП А для пластин с радиусом 0.4—3.2 мм. ТИП В для пластин с радиусом 4.0—5.0 мм.

Фрезы с другими геометрическими размерами изготавливаются по специальному заказу.

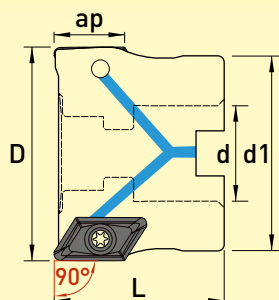

**ФРЕЗЫ ТОРЦОВЫЕ НАСАДНЫЕ
(угол в плане 90°)**

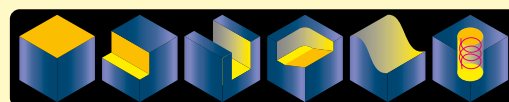

Артикул	D мм	Статус	L мм	d мм	d1 мм	ap мм	Z	Каналы СОЖ	Пластины	Винт	Ключ
КМ90AL20-040Z03040000D16P19-C-A/B*	40	●	40	16	34		3	✓	КМАЛ20FR-19X5...	VD0408	T15
КМ90AL20-050Z04050000D22P19-C-A/B*	50	●	50	22	42		4	✓			
КМ90AL20-063Z05050000D22P19-C-A/B*	63	●	50	22	49		5	✓			
КМ90AL20-080Z05050000D27P19-C-A/B*	80	●	50	27	57		5	✓			
КМ90AL20-100Z06063000D32P19-C-A/B*	100	●	63	32	67		6	✓			
КМ90AL20-125Z07063000D40P19-C-A/B*	125	●	63	40	87		7	✓			

* ТИП А для пластин с радиусом 0.4—3.2 мм. ТИП В для пластин с радиусом 4.0—5.0 мм.

Фрезы с другими геометрическими размерами изготавливаются по специальному заказу.



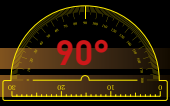

ФРЕЗЫ: ТИП КМ90АL20

«Alu-Line-Big»

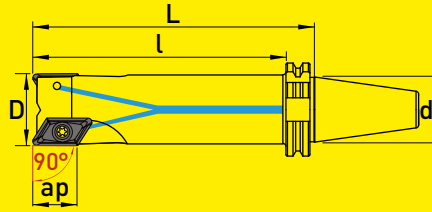
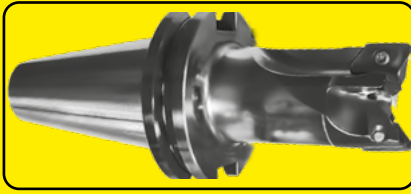

ХВОСТОВИК DIN 69871



Артикул	D мм	Статус	d мм	L мм	L мм	ap мм	Z	Каналы СОЖ	Пластины	Винт	Ключ
КМ90АL20-025Z02081100SK40P19-C-A/B*	25	○	63.55	81	100	17	2	✓	КМАL20FR-19X5...	VD0408	T15
КМ90АL20-025Z02091110SK40P19-C-A/B*	25	○		91	110		2	✓			
КМ90АL20-025Z02111130SK40P19-C-A/B*	25	○		111	130		2	✓			
КМ90АL20-025Z02131150SK40P19-C-A/B*	25	○		131	150		2	✓			
КМ90АL20-032Z02081110SK40P19-C-A/B*	32	○		81	110		2	✓			
КМ90АL20-032Z02111130SK40P19-C-A/B*	32	○		111	130		2	✓			
КМ90АL20-032Z02131150SK40P19-C-A/B*	32	○		131	150		2	✓			
КМ90АL20-032Z03091110SK40P19-C-A/B*	32	○		91	110		3	✓			
КМ90АL20-032Z03111130SK40P19-C-A/B*	32	○		111	130		3	✓			
КМ90АL20-040Z03091110SK40P19-C-A/B*	40	○		91	110		3	✓			
КМ90АL20-040Z03111130SK40P19-C-A/B*	40	○		111	130		3	✓			
КМ90АL20-040Z03131150SK40P19-C-A/B*	40	○		131	150		3	✓			
КМ90АL20-050Z03091110SK40P19-C-A/B*	50	○		91	110		3	✓			
КМ90АL20-050Z03111130SK40P19-C-A/B*	50	○		111	130		3	✓			
КМ90АL20-050Z03131150SK40P19-C-A/B*	50	○		131	150		3	✓			
КМ90АL20-050Z04091110SK40P19-C-A/B*	50	○		91	110		4	✓			
КМ90АL20-050Z04111130SK40P19-C-A/B*	50	○		111	130		4	✓			
КМ90АL20-050Z04131150SK40P19-C-A/B*	50	○		131	150		4	✓			

* ТИП А для пластин с радиусом 0.4—3.2 мм. ТИП В для пластин с радиусом 4.0—5.0 мм.

Фрезы с другими геометрическими размерами изготавливаются по специальному заказу.

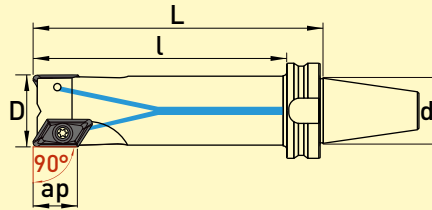
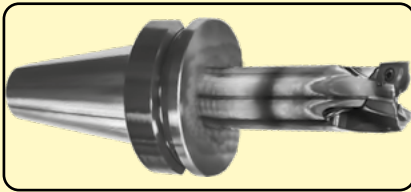

ХВОСТОВИК (MAS 403-BT)

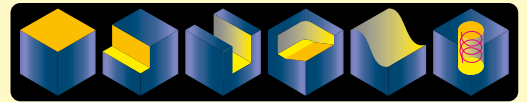

Артикул	D мм	Статус	d мм	L мм	L мм	ap мм	Z	Каналы СОЖ	Пластины	Винт	Ключ
КМ90АL20-025Z02083110BT40P19-C-A/B*	25	○	63	83	110	17	2	✓	КМАL20FR-19X5...	VD0408	T15
КМ90АL20-025Z02093120BT40P19-C-A/B*	25	○		93	120		2	✓			
КМ90АL20-025Z02113140BT40P19-C-A/B*	25	○		113	140		2	✓			
КМ90АL20-025Z02133160BT40P19-C-A/B*	25	○		133	160		2	✓			
КМ90АL20-032Z02093120BT40P19-C-A/B*	32	○		93	120		2	✓			
КМ90АL20-032Z02113140BT40P19-C-A/B*	32	○		113	140		2	✓			
КМ90АL20-032Z02133160BT40P19-C-A/B*	32	○		133	160		2	✓			
КМ90АL20-032Z03093120BT40P19-C-A/B*	32	○		93	120		3	✓			
КМ90АL20-032Z03113140BT40P19-C-A/B*	32	○		113	140		3	✓			
КМ90АL20-040Z03093120BT40P19-C-A/B*	40	○		93	120		3	✓			
КМ90АL20-040Z03113140BT40P19-C-A/B*	40	○		113	140		3	✓			
КМ90АL20-040Z03133160BT40P19-C-A/B*	40	○		133	160		3	✓			
КМ90АL20-050Z03093120BT40P19-C-A/B*	50	○		93	120		3	✓			
КМ90АL20-050Z03113140BT40P19-C-A/B*	50	○		113	140		3	✓			
КМ90АL20-050Z03133160BT40P19-C-A/B*	50	○		133	160		3	✓			
КМ90АL20-050Z04093120BT40P19-C-A/B*	50	○		93	120		4	✓			
КМ90АL20-050Z04113140BT40P19-C-A/B*	50	○		113	140		4	✓			
КМ90АL20-050Z04133160BT40P19-C-A/B*	50	○		133	160		4	✓			

* ТИП А для пластин с радиусом 0.4—3.2 мм. ТИП В для пластин с радиусом 4.0—5.0 мм.

Фрезы с другими геометрическими размерами изготавливаются по специальному заказу.





Рис. 1



Рис. 2

ФРЕЗЫ ТОРЦОВО-ЦИЛИНДРИЧЕСКИЕ
НАСАДНЫЕ (угол в плане 90°).
ХВОСТОВИК HSK-A

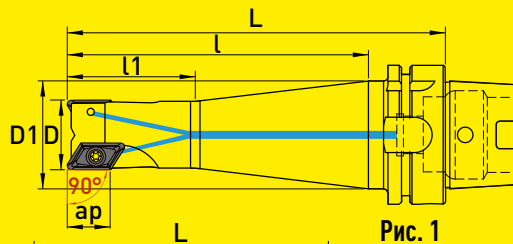
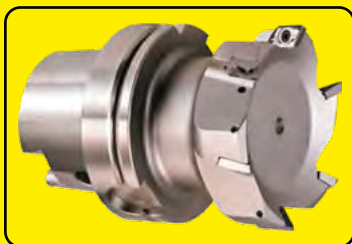

HSK-A	Артикул	D мм	Статус	Рис.	D1 мм	d мм	l1 мм	l мм	L мм	ap мм	Z	Каналы СОЖ	Пластины	Винт	Ключ
63	KM90AL20-025Z02079105HSK063P19-C-A/B*	25	○	2	-	63	-	79	105	17	2	✓	KMAL20FR-19X5...	VD0408	T15
	KM90AL20-025Z02089115HSK063P19-C-A/B*	25	○	2	-		-	89	115		2	✓			
	KM90AL20-025Z02109135HSK063P19-C-A/B*	25	○	2	-		-	109	135		2	✓			
	KM90AL20-025Z02129155HSK063P19-C-A/B*	25	○	2	-		-	129	155		2	✓			
	KM90AL20-032Z02079115HSK063P19-C-A/B*	32	○	2	-		-	79	115		2	✓			
	KM90AL20-032Z02109135HSK063P19-C-A/B*	32	○	2	-		-	109	135		2	✓			
	KM90AL20-032Z02129155HSK063P19-C-A/B*	32	○	2	-		-	129	155		2	✓			
	KM90AL20-032Z02137163HSK063P19-C-A/B*	32	⊙	1	53		-	58	137		163	2			
	KM90AL20-032Z03089115HSK063P19-C-A/B*	32	○	2	-	-	89	115	3		✓				
	KM90AL20-032Z03109135HSK063P19-C-A/B*	32	○	2	-	-	109	135	3		✓				
	KM90AL20-040Z03089115HSK063P19-C-A/B*	40	○	2	-	-	89	115	3		✓				
	KM90AL20-040Z03109135HSK063P19-C-A/B*	40	○	2	-	-	109	135	3		✓				
	KM90AL20-040Z03129155HSK063P19-C-A/B*	40	○	2	-	-	129	155	3		✓				
	KM90AL20-050Z03089115HSK063P19-C-A/B*	50	○	2	-	63	-	89	115		3	✓			
	KM90AL20-050Z03109135HSK063P19-C-A/B*	50	○	2	-	-	109	135	3		✓				
	KM90AL20-050Z03129155HSK063P19-C-A/B*	50	○	2	-	-	129	155	3		✓				
KM90AL20-050Z04089115HSK063P19-C-A/B*	50	○	2	-	-	89	115	4	✓						
KM90AL20-050Z04109135HSK063P19-C-A/B*	50	○	2	-	-	109	135	4	✓						
KM90AL20-050Z04129155HSK063P19-C-A/B*	50	○	2	-	-	129	155	4	✓						
100	KM90AL20-080Z05066095HSK100P19-C-A/B*	80	⊙	2	-	-	-	66	95	5	✓				
	KM90AL20-100Z06066095HSK100P19-C-A/B*	100	⊙	2	-	-	-	66	95	6	✓				

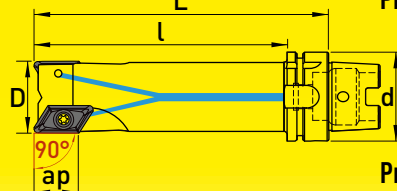
* ТИП А для пластин с радиусом 0.4—3.2 мм. ТИП В для пластин с радиусом 4.0—5.0 мм.

Фрезы с другими геометрическими размерами изготавливаются по специальному заказу.

ПЛАСТИНЫ ДЛЯ ФРЕЗ: ТИП КМ90AL20

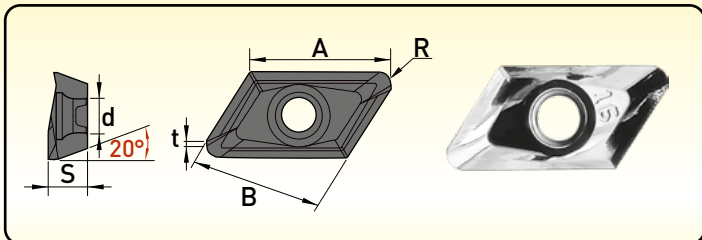

P	
M	
K	
N	★
S	
H	

СПЛАВЫ
без покрытия

Артикул	A мм	B мм	R мм	t мм	d мм	S мм	ap мм	Fz мм/зуб	FN10
KMAL20FR-19X504FR-AL	18.0	16.4	0.4	1.4	4.4	5	16.0	0.1-0.4	⊙
KMAL20FR-19X508FR-AL	18.0		0.8	1.0			16.0		○
KMAL20FR-19X516FR-AL	17.5		1.6	0.5			15.5		○
KMAL20FR-19X520FR-AL	17.5		2.0	0.5			15.5		⊙
KMAL20FR-19X530FR-AL	17.0		3.0	0.7			15.0		⊙
KMAL20FR-19X532FR-AL	17.0		3.2	0.5			15.0		⊙
KMAL20FR-19X540FR-AL	16.5		4.0	0.5			14.5		○
KMAL20FR-19X550FR-AL	16.0		5.0	0.4			14.0		○

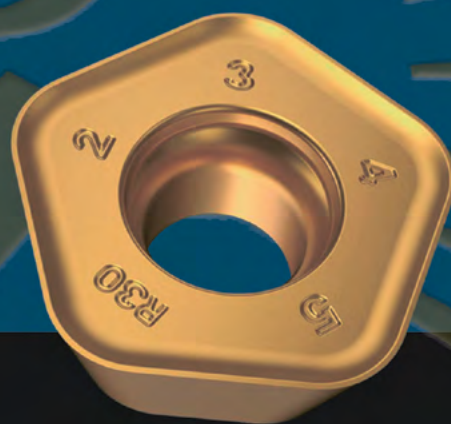
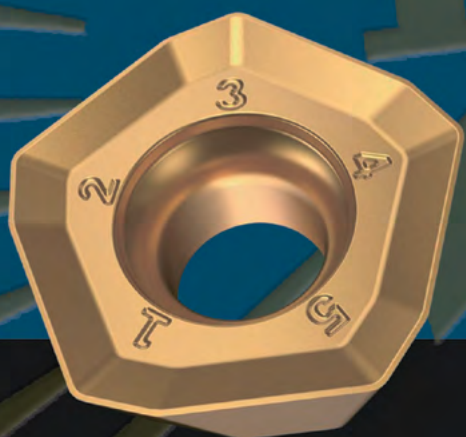

ИНСТРУМЕНТАЛЬНЫЙ ЗАВОД
«ВОСХОД»

**РАЗДЕЛ 5.
ФРЕЗЫ СО СМЕННЫМИ
ТВЕРДОСПЛАВНЫМИ ПЛАСТИНАМИ
(обработка групп материалов Р, М, К, S, Н)**



ФРЕЗЫ: ТИП М900111М



ГОЛОВКИ ФРЕЗЕРНЫЕ С РЕЗЬБОВЫМ ХВОСТОВИКОМ (угол в плане 90°)

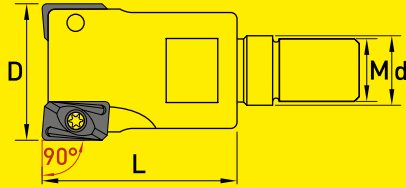

Артикул	Статус	D мм	L мм	d мм	M	Z	Пластины	Винт	Ключ
M900111M-016Z02026000M08P11	○	16	26	8.5	M8	2	M0111MT-11X3 M0111GT-11X3	SM2560	T08
M900111M-020Z02030000M10P11	○	20	30	10.5	M10	2			
M900111M-020Z03030000M10P11	○	20	30	10.5	M10	3			
M900111M-025Z04035000M12P11	○	25	35	12.5	M12	4			
M900111M-032Z05040000M16P11	○	32	40	17.0	M16	5			
M900111M-033Z05040000M16P11	○	33	40	17.0	M16	5			
M900111M-025Z02035000M12P16	○	25	35	12.5	M12	2	M0111MT-1604 M0111GT-1604	SM4090	T15
M900111M-032Z03040000M16P16	○	32	40	17.0	M16	3			

Фрезы с другими характеристиками и геометрическими размерами изготавливаются по специальному заказу.

ФРЕЗЫ КОНЦЕВЫЕ С ЦИЛИНДРИЧЕСКИМ ХВОСТОВИКОМ (угол в плане 90°)



Рис. 1



Рис. 2

Артикул	Рисунок	Статус	D мм	L мм	L мм	d мм	Z	Пластины	Винт	Ключ
M900111M-010Z01030120S10P11	1	⊙	10	30	120	10	1	M0111MT-11X3 M0111GT-11X3	SM2560	T08
M900111M-012Z01030120S12P11	1	⊙	12	30	120	12	1			
M900111M-013Z01000120S12P11	2	⊙	13	30	120	12	1			
M900111M-016Z02040120S16P11	1	⊙	16	40	120	16	2			
M900111M-016Z02040160S16P11	1	⊙	16	40	160	16	2			
M900111M-017Z02000160S16P11	2	⊙	17	40	160	16	2			
M900111M-020Z02035150S20P11	1	○	20	35	150	20	2			
M900111M-020Z03040120S20P11	1	⊙	20	40	120	20	3			
M900111M-020Z03050160S20P11	1	⊙	20	50	160	20	3			
M900111M-021Z03000120S20P11	2	⊙	21	40	120	20	3			
M900111M-021Z03000160S20P11	2	⊙	21	50	160	20	3			
M900111M-025Z04035100S25P11	1	○	25	35	100	25	4			
M900111M-025Z03050160S25P11	1	⊙	25	50	160	25	3			
M900111M-025Z03075200S25P11	1	⊙	25	75	200	25	3			
M900111M-026Z03000160S25P11	2	⊙	26	50	160	25	3			
M900111M-026Z03000200S25P11	2	⊙	26	50	200	25	3			
M900111M-030Z04000120S25P11	2	○	30	40	120	25	4			
M900111M-030Z03000160S25P11	2	⊙	30	50	160	25	3			
M900111M-030Z03000200S25P11	2	⊙	30	75	200	25	3			
M900111M-032Z05040120S32P11	1	○	32	40	120	32	5			

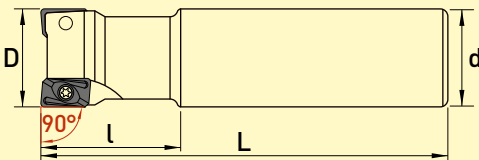
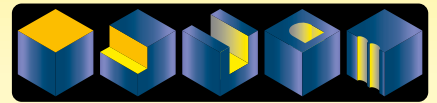
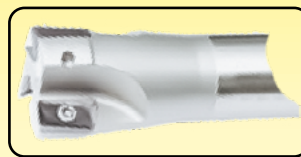
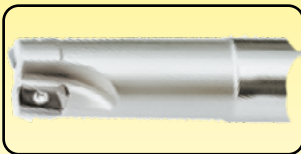
⊙ — стандартная позиция; ○ — продукция изготавливается по спецзаказу потребителя, минимальная партия и сроки — по запросу.

ОКОНЧАНИЕ ТАБЛИЦЫ

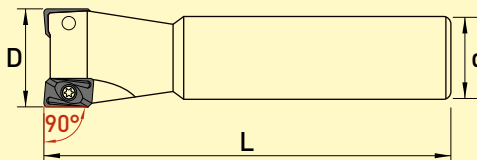
Артикул	Рисунок	Статус	D мм	L мм	L мм	d мм	Z	Пластины	Винт	Ключ
M900111M-025Z02040150S25P16	1	○	25	40	150	25	2	M0111MT-1604 M0111GT-1604	SM4090	T15
M900111M-025Z02070200S25P16	1	○	25	70	200	25	2			
M900111M-025Z03050160S25P16	1	⊙	25	50	160	25	3			
M900111M-025Z03075200S25P16	1	⊙	25	75	200	25	3			
M900111M-026Z03000160S25P16	2	⊙	26	50	160	25	3			
M900111M-026Z03000200S25P16	2	⊙	26	50	200	25	3			
M900111M-032Z03000160S25P16	2	⊙	32	50	160	25	3			
M900111M-032Z03000200S25P16	2	⊙	32	50	200	25	3			
M900111M-032Z03050160S32P16	1	⊙	32	50	160	32	3			
M900111M-032Z03080200S32P16	1	⊙	32	80	200	32	3			
M900111M-032Z03080250S32P16	1	⊙	32	80	250	32	3			
M900111M-035Z03000160S32P16	2	⊙	35	50	160	32	3			
M900111M-035Z03000200S32P16	2	⊙	35	50	200	32	3			
M900111M-035Z03000250S32P16	2	⊙	35	60	250	32	3			
M900111M-040Z04000160S32P16	2	⊙	40	50	160	32	4			
M900111M-040Z04000200S32P16	2	⊙	40	50	200	32	4			

Фрезы с другими характеристиками и геометрическими размерами изготавливаются по специальному заказу.

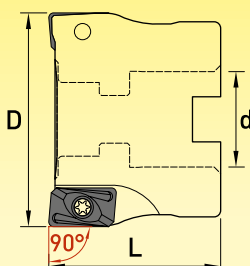

ФРЕЗЫ ТОРЦОВЫЕ НАСАДНЫЕ
(угол в плане 90°)

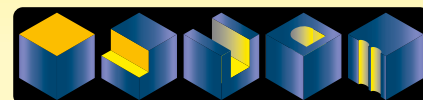

Артикул	Статус	D мм	L мм	d мм	Z	Пластины	Винт	Ключ
M900111M-040Z04042000D16P11	⊙	40	42	16	4	M0111MT-11X3 M0111GT-11X3	SM2560	T08
M900111M-040Z05040000D16P11	⊙	40	40	16	5			
M900111M-050Z04050000D22P11	⊙	50	50	22	4			
M900111M-050Z06045000D22P11	⊙	50	45	22	6			
M900111M-063Z07045000D22P11	⊙	63	45	22	7			
M900111M-063Z07050000D22P11	⊙	63	50	22	7			
M900111M-080Z08050000D27P11	⊙	80	50	27	8			
M900111M-100Z10050000D32P11	⊙	100	50	32	10			
M900111M-040Z04040000D16P16	⊙	40	40	16	4	M0111MT-1604 M0111GT-1604	SM4090	T15
M900111M-040Z04048000D16P16	⊙	40	48	16	4			
M900111M-040Z04048000D22P16	⊙	40	48	22	4			
M900111M-050Z04050000D22P16	⊙	50	50	22	4			
M900111M-050Z05045000D22P16	⊙	50	45	22	5			
M900111M-050Z05050000D22P16	⊙	50	50	22	5			
M900111M-063Z04050000D22P16	⊙	63	50	22	4			
M900111M-063Z06045000D22P16	⊙	63	45	22	6			
M900111M-063Z05050000D22P16	⊙	63	50	22	5			
M900111M-063Z06050000D22P16	⊙	63	50	22	6			
M900111M-080Z06050000D27P16	⊙	80	50	27	6			
M900111M-080Z07050000D27P16	⊙	80	50	27	7			
M900111M-100Z06050000D32P16	⊙	100	50	32	6			
M900111M-100Z08050000D32P16	⊙	100	50	32	8			
M900111M-125Z09055000D40P16	⊙	125	55	40	9			
M900111M-125Z08063000D40P16	⊙	125	63	40	8			
M900111M-160Z09063000D40P16	⊙	160	63	40	9			
M900111M-160Z10063000D40P16	⊙	160	63	40	10			
M900111M-200Z09063000D60P16	⊙	200	63	60	9			

Фрезы с другими характеристиками и геометрическими размерами изготавливаются по специальному заказу.

⊙ — стандартная позиция; ○ — продукция изготавливается по спецзаказу потребителя, минимальная партия и сроки — по запросу.



ФРЕЗЫ: ТИП М900111М

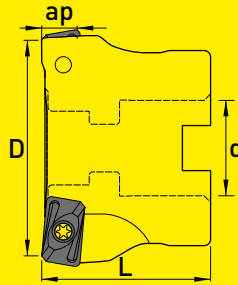

**ФРЕЗЫ ТОРЦОВЫЕ НАСАДНЫЕ
ДЛЯ ОБРАБОТКИ ПЛОСКОСТЕЙ
(ДЛЯ ИСПОЛЬЗОВАНИЯ
ВНУТРЕННИХ УГЛОВ ПЛАСТИН)**



Артикул	Статус	D мм	L мм	d мм	Z	Пластины	Винт	Ключ
MX00111M-063Z04050000D22P16	⊙	63	50	22	4	M0111MT-1604 M0111GT-1604	SM4090	T15
MX00111M-080Z05050000D27P16	⊙	80	50	27	5			
MX00111M-100Z06050000D32P16	⊙	100	50	32	6			
MX00111M-125Z06063000D40P16	⊙	125	63	40	6			

Фрезы с другими геометрическими размерами изготавливаются по специальному заказу.

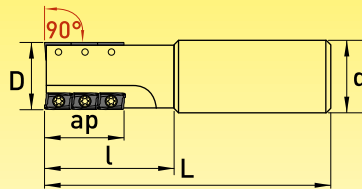

**ФРЕЗЫ ТОРЦОВО-ЦИЛИНДРИЧЕСКИЕ
С ЦИЛИНДРИЧЕСКИМ ХВОСТОВИКОМ
(угол в плане 90°)**



Артикул	Статус	D мм	ap мм	L мм	L мм	d мм	Z	Zn	Пластины	Винт	Ключ
M900111M-020Z01042107S20P11N05	⊙	20	28	42	107	20	1	5	M0111MT-11X3 M0111GT-11X3	SM2560	T08
M900111M-025Z02050125S25P11N08	⊙	25	35	50	125	25	2	8			
M900111M-032Z03060135S32P11N15	⊙	32	44	60	135	32	3	15			
M900111M-040Z03000175S32P11N24	⊙	40	72	94	175	32	3	24			
M900111M-032Z02055135S32P16N06	⊙	32	42	55	135	32	2	6	M0111MT-1604 M0111GT-1604	SM4090	T15
M900111M-040Z02000175S32P16N10	⊙	40	68	94	175	32	2	10			
M900111M-040Z03000175S32P16N15	⊙	40	68	94	175	32	3	15			

Фрезы с другими геометрическими размерами изготавливаются по специальному заказу.

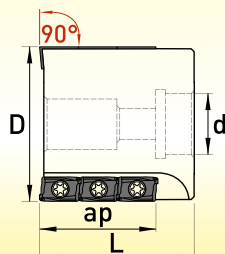

**ФРЕЗЫ ТОРЦОВО-ЦИЛИНДРИЧЕСКИЕ
НАСАДНЫЕ (угол в плане 90°)**



Артикул	Статус	D мм	ap мм	L мм	d мм	Z	Zn	Пластины	Винт	Ключ
M900111M-050Z03069000D22P16N09	⊙	50	42	69	22	3	9	M0111MT-1604 M0111GT-1604	SM4090	T15

Фрезы с другими геометрическими размерами изготавливаются по специальному заказу.

ПЛАСТИНЫ ДЛЯ ФРЕЗ: ТИП 900111М

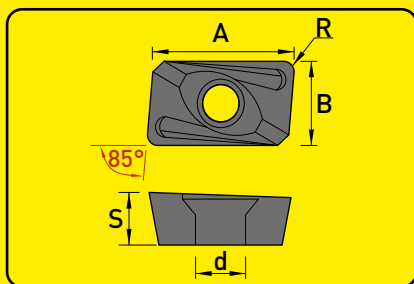

P			★			★		★	★	
M	★	★	★	★		★	★	★	★	★
K		★	★			★			★	
N										★
S	★	★	★	★	★				★	
H		★								

С П Л А В Ы

с покрытием

без покрытия

Артикул	A мм	B мм	S мм	d мм	R мм	ap max мм	fz мм/зуб	RMS30	RU15	RU30	VS25	VS10	VM25	VM20	VM25M	OPM20	RMT20	FN10							
M0111MT-11X3PDER-BM	11.0	6.350	3.50	2.8	0.8-1.6	0.5-4.0	0.1-0.2	●	●	●		●	●	●	●		●								
M0111MT-11X3PDER-BN								●	●	●		●	●	●	●										
M0111MT-11X3PDTR								●	●	●															
M0111MT-11X3PDER-FD																	●								
M0111MT-11X3PDER-RD																				●	●	●			
M0111MT-11X3PDER-MG																				●	●	●			
M0111MT-11X3PDER-RX																		●	●	●	●	●			
M0111GT-11X3PDFR-AL						0.5-9.0	0.1-0.4											●							
M0111MT-1604PDER-BM	16.5	9.525	4.76	4.4	0.8-1.6	0.5-7.0	0.12-0.28	●	●	●		●	●	●	●										
M0111MT-1604PDER-BN								●	●	●	●	●	●	●											
M0111MT-1604PDTR								●	●	●															
M0111MT-1604PDER-BH																							●		
M0111MT-1604PDER-FD																		●							
M0111MT-1604PDER-EM															●										
M0111MT-1604PDR-GAS																		●							
M0111GT-1604PDFR-AL						0.5-11.0	0.1-0.4											●							

Пластины серии M0111MT(GT) взаимозаменяемы со стандартными пластинами типа APMT (APGT).



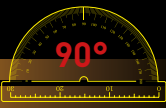

ФРЕЗЫ: ТИП SM901411

ГОЛОВКИ ФРЕЗЕРНЫЕ С РЕЗЬБОВЫМ ХВОСТОВИКОМ (угол в плане 90°)

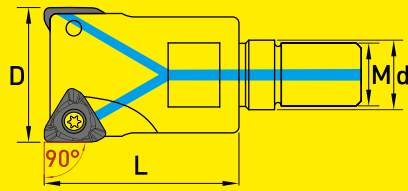
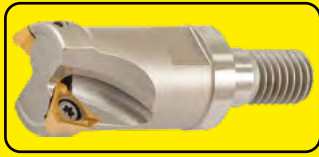

Артикул	Статус	D мм	L мм	d мм	M	Z	Каналы СОЖ	Пластины	Винт	Ключ
SM901411-016Z02023000M08P06	☉	16	23	13	M08	2	—	SM1411MX-06...	TP06020	T06
SM901411-017Z02023000M08P06	☉	17	23	13	M08	2	—			
SM901411-020Z03035000M10P06	☉	20	35	18	M10	3	—			
SM901411-020Z04035000M10P06	☉	20	35	18	M10	4	—			
SM901411-025Z04035000M12P06	☉	25	35	21	M12	4	—			
SM901411-025Z05035000M12P06	☉	25	35	21	M12	5	—			
SM901411-032Z06043000M16P06	☉	32	43	29	M16	6	—			
SM901411-032Z07043000M16P06	☉	32	43	29	M16	7	—			
SM901411-035Z07043000M16P06	☉	35	43	29	M16	7	—			
SM901411-020Z02035000M10P10	☉	20	35	10.5	M10	2	—			
SM901411-020Z02035000M10P10C	☉	20	35	18.0	M10	2	✓			
SM901411-021Z02035000M10P10	☉	21	35	10.5	M10	2	—			
SM901411-025Z03035000M12P10	☉	25	35	12.5	M12	3	—			
SM901411-025Z03035000M12P10C	☉	25	35	21.0	M12	3	✓			
SM901411-026Z03035000M12P10	☉	26	35	12.5	M12	3	—			
SM901411-032Z05043000M16P10	☉	32	43	29.0	M16	5	—			
SM901411-032Z05043000M16P10C	☉	32	43	17.0	M16	5	✓			
SM901411-033Z05043000M16P10	☉	33	43	17.0	M16	5	—			
SM901411-033Z05043000M16P10C	☉	33	43	17.0	M16	5	✓			

Фрезы с каналами для подвода СОЖ и другими геометрическими размерами изготавливаются по специальному заказу.

ФРЕЗЫ КОНЦЕВЫЕ С ЦИЛИНДРИЧЕСКИМ ХВОСТОВИКОМ (угол в плане 90°)

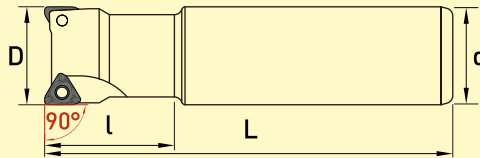

Артикул	Статус	D мм	l мм	L мм	d мм	Z	Пластины	Винт	Ключ
SM901411-012Z01020080S12P06	☉	12	20	80	12	1	SM1411MX-06...	TP06020	T06
SM901411-014Z01020080S12P06	☉	14	20	80	12	1			
SM901411-016Z02025110S16P06	☉	16	25	110	16	2			
SM901411-016Z02025150S16P06	☉	16	25	150	16	2			
SM901411-016Z03025110S16P06	☉	16	25	110	16	3			
SM901411-017Z02025200S16P06	☉	17	25	200	16	2			
SM901411-017Z03025110S16P06	☉	17	25	110	16	3			
SM901411-018Z03025150S16P06	☉	18	25	150	16	3			
SM901411-019Z03025150S16P06	☉	19	25	150	16	3			
SM901411-020Z03025160S20P06	☉	20	25	160	20	3			
SM901411-020Z04025160S19P06	☉	20	25	160	19	4			
SM901411-021Z04025160S20P06	☉	21	25	160	20	4			
SM901411-020Z02050130S20P10	☉	20	50	130	20	2			
SM901411-025Z03055150S25P10	☉	25	55	150	25	3	SM1411MX-1505	ST4014	T15
SM901411-033Z03045200S32P15	☉	33	45	200	32	3			
SM901411-040Z04045200S32P15	☉	40	45	200	32	4			

Фрезы с каналами для подвода СОЖ и другими геометрическими размерами изготавливаются по специальному заказу.

☉ — стандартная позиция; ○ — продукция изготавливается по спецзаказу потребителя, минимальная партия и сроки — по запросу.

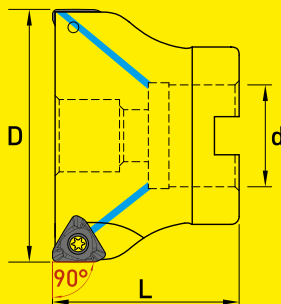

ФРЕЗЫ ТОРЦОВЫЕ НАСАДНЫЕ
(угол в плане 90°)



Артикул	Статус	D мм	L мм	d мм	Z	Каналы СОЖ	Пластины	Винт	Ключ
SM901411-032Z060320000D16P06	⊙	32	32	16	6	—	SM1411MX-06...	TP06020	T06
SM901411-032Z070320000D16P06	⊙	32	32	16	7	—			
SM901411-035Z070350000D16P06	⊙	35	35	16	7	—			
SM901411-040Z080400000D16P06	⊙	40	40	16	8	—			
SM901411-040Z080400000D22P06	⊙	40	40	22	8	—			
SM901411-050Z060500000D22P10C	⊙	50	50	22	6	✓	SM1411MX-1004	ST2517	T08
SM901411-050Z070500000D22P10	⊙	50	50	22	7	—			
SM901411-063Z070500000D22P10C	⊙	63	50	22	7	✓			
SM901411-063Z090500000D22P10	⊙	63	50	22	9	—			
SM901411-040Z040400000D16P15C	⊙	40	40	16	4	✓	SM1411MX-1505	ST4004	T15
SM901411-050Z050400000D22P15C	⊙	50	40	22	5	✓			
SM901411-063Z060400000D22P15C	⊙	63	40	22	6	✓			
SM901411-080Z080500000D27P15C	⊙	80	50	27	8	✓			

Фрезы с каналами для подвода СОЖ и другими геометрическими размерами изготавливаются по специальному заказу.

ПЛАСТИНЫ ДЛЯ ФРЕЗ: ТИП SM901411

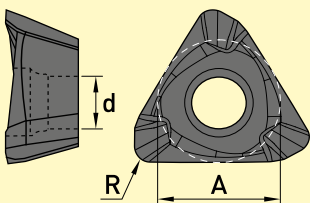

P	★	★	★	
M	★		★	
K	★	★	☆	
N				★
S			☆	
H				

						С П Л А В Ы			
						с покрытием			без покрытия
УРП	Артикул	A мм	R мм	d мм		VM25	VPK25M	SU32	SN20
6	SM1411MX-060304-M	4	0.4	2.30		●	●		
10	SM1411MX-100408-M	6	0.8	3.15		●	●		
15	SM1411MX-150504-AL	9	0.4	4.85					●
	SM1411MX-150508-AL							●	
	SM1411MX-150508-M		0.8		●	●	●		
19	SM1411MX-190608-M	12		7.00				●	

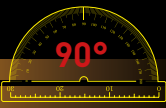

ФРЕЗЫ: ТИП RM900800

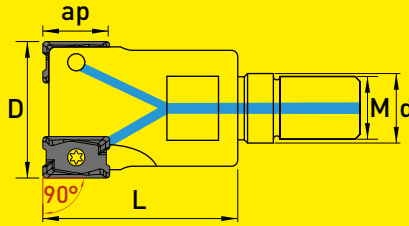

ГОЛОВКИ ФРЕЗЕРНЫЕ С РЕЗЬБОВЫМ ХВОСТОВИКОМ (угол в плане 90°)



Артикул	Статус	D мм	L мм	d мм	ap мм	M	Z	Каналы СОЖ	Пластины	Винт	Ключ
RM900800-016Z02025000M08P11-C	○	16	25	8.5	9	M8	2	✓	RM0800HX-11T4	SDS2565	T08
RM900800-017Z02025000M08P11-C	○	17	25	8.5		M8	2	✓			
RM900800-020Z03030000M10P11-C	○	20	30	10.5		M10	3	✓			
RM900800-021Z03030000M10P11-C	○	21	30	10.5		M10	3	✓			
RM900800-025Z03035000M12P11-C	○	25	35	12.5		M12	3	✓			
RM900800-025Z04035000M12P11-C	○	25	35	12.5		M12	4	✓			
RM900800-026Z04035000M12P11	○	26	35	12.5		M12	4	—			
RM900800-032Z04043000M16P11-C	○	32	43	16.5		M16	4	✓			
RM900800-032Z05043000M16P11-C	○	32	43	16.5		M16	5	✓			
RM900800-035Z05043000M16P11-C	○	35	43	16.5		M16	5	✓			

Фрезы с другими геометрическими размерами изготавливаются по специальному заказу.

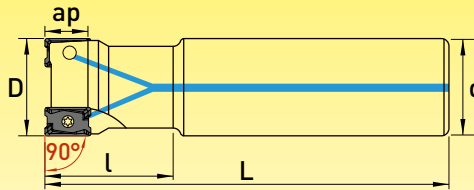

ФРЕЗЫ КОНЦЕВЫЕ С ЦИЛИНДРИЧЕСКИМ ХВОСТОВИКОМ (угол в плане 90°)



Артикул	Статус	D мм	L мм	L мм	d мм	ap мм	Z	Каналы СОЖ	Пластины	Винт	Ключ
RM900800-016Z02030090S16P11-C	○	16	30	90	16	9	2	✓	RM0800HX-11T4	SDS2565	T08
RM900800-017Z02000090S16P11-C	○	17	—	90	16		2	✓			
RM900800-018Z02000090S16P11-C	○	18	—	90	16		2	✓			
RM900800-020Z03045110S20P11-C	○	20	45	110	20		3	✓			
RM900800-021Z03000110S20P11-C	○	21	—	110	20		3	✓			
RM900800-025Z04050130S25P11-C	○	25	50	130	25		4	✓			
RM900800-026Z04000130S25P11-C	○	26	—	130	25		4	✓			
RM900800-032Z05060150S32P11-C	○	32	60	150	32		5	✓			
RM900800-032Z03090200S32P11-C	○	32	90	200	32		3	✓			
RM900800-035Z05000150S32P11-C	○	35	—	150	32		5	✓			
RM900800-035Z03000200S32P11-C	○	35	—	200	32		3	✓			

Фрезы с другими геометрическими размерами изготавливаются по специальному заказу.

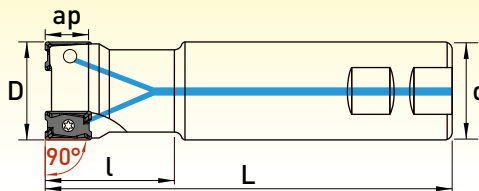
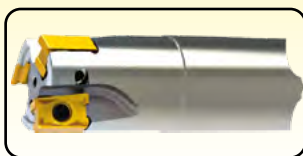

ФРЕЗЫ КОНЦЕВЫЕ С ХВОСТОВИКОМ WELDON (угол в плане 90°)



Артикул	Статус	D мм	L мм	L мм	d мм	ap мм	Z	Каналы СОЖ	Пластины	Винт	Ключ
RM900800-016Z02030090W16P11-C	○	16	30	90	16	9	2	✓	RM0800HX-11T4	SDS2565	T08
RM900800-017Z02000090W16P11-C	○	17	—	90	16		2	✓			
RM900800-018Z02000090W16P11-C	○	18	—	90	16		2	✓			
RM900800-020Z03045110W20P11-C	○	20	45	110	20		3	✓			
RM900800-021Z03000110W20P11-C	○	21	—	110	20		3	✓			
RM900800-025Z04050130W25P11-C	○	25	50	130	25		4	✓			
RM900800-026Z04000130W25P11-C	○	26	—	130	25		4	✓			
RM900800-032Z05060150W32P11-C	○	32	60	150	32		5	✓			

Фрезы с другими геометрическими размерами изготавливаются по специальному заказу.

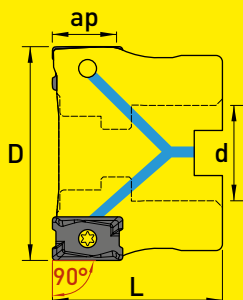

ФРЕЗЫ ТОРЦОВЫЕ НАСАДНЫЕ
(угол в плане 90°)

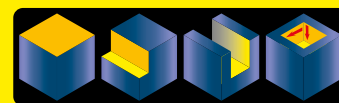

Артикул	Статус	D мм	L мм	d мм	ap мм	Z	Каналы СОЖ	Пластины	Винт	Ключ
RM900800-040Z04040000D16P11-C	○	40	40	16	9	4	✓	RM0800HX-11T4	SDS2565	T08
RM900800-040Z06040000D16P11-C	○	40	40	16		6	✓			
RM900800-040Z07040000D16P11-C	○	40	40	16		7	✓			
RM900800-050Z05040000D22P11-C	○	50	40	22		5	✓			
RM900800-050Z07040000D22P11-C	○	50	40	22		7	✓			
RM900800-050Z09040000D22P11-C	○	50	40	22		9	✓			
RM900800-063Z06040000D22P11-C	○	63	40	22		6	✓			
RM900800-063Z09040000D22P11-C	○	63	40	22		9	✓			
RM900800-080Z08050000D27P11-C	○	80	50	27		8	✓			
RM900800-080Z10050000D27P11-C	○	80	50	27		10	✓			

Фрезы с другими геометрическими размерами изготавливаются по специальному заказу.

ПЛАСТИНЫ ДЛЯ ФРЕЗ: ТИП RM900800

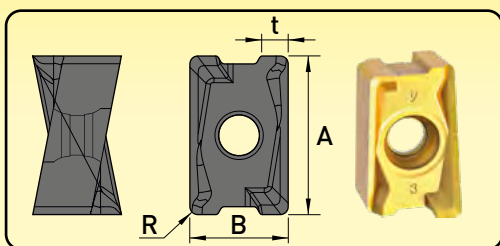

	★	★	★
P		★	★
M	★	★	★
K	★		
N			
S	★	★	
H	★		

				СПЛАВЫ		
				с покрытием		
Артикул	R мм	ap мм	fz мм/зуб	RU15	RMS30	RMS30A
RM0800HX-11T404AFN	0.4	0.3-9.0	0.15-050	●	●	
RM0800HX-11T408AFN	0.8			●	●	●
RM0800HX-11T410AFN	1.0			●	●	
RM0800HX-11T412AFN	1.2			●	●	
RM0800HX-11T416AFN	1.6					●
RM0800HX-11T420AFN	2.0					●
RM0800HX-11T424AFN	2.4					●

РЕКОМЕНДОВАННЫЕ ЗНАЧЕНИЯ ПАРАМЕТРОВ РЕЗАНИЯ, ПРЕДСТАВЛЕННЫЕ В ТАБЛИЦЕ, ЯВЛЯЮТСЯ ОРИЕНТИРОВОЧНЫМИ И ДОЛЖНЫ ПРИМЕНЯТЬСЯ И КОРРЕКТИРОВАТЬСЯ В ЗАВИСИМОСТИ ОТ КОНКРЕТНЫХ УСЛОВИЙ ОБРАБОТКИ.



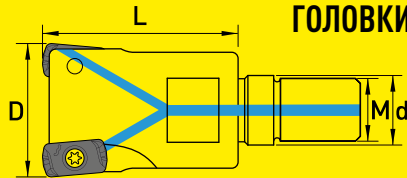

ГОЛОВКИ ФРЕЗЕРНЫЕ С РЕЗЬБОВЫМ ХВОСТОВИКОМ ДЛЯ ВЫСОКИХ ПОДАЧ



Артикул	Статус	D мм	L мм	d мм	M	Z	Каналы СОЖ	Пластины	Винт	Ключ
RMHFL00-008Z01017000M04P04	☉	8	17	4.5	M4	1	—	RHFL00MU-04X2...	SM1837	T06
RMHFL00-009Z01017000M04P04	☉	9	17	4.5	M4	1	—			
RMHFL00-010Z02017000M05P04	☉	10	17	5.5	M5	2	—			
RMHFL00-011Z02017000M05P04	☉	11	17	5.5	M5	2	—			
RMHFL00-012Z03017000M06P04	☉	12	17	6.5	M6	3	—			
RMHFL00-013Z03017000M06P04	☉	13	17	6.5	M6	3	—			
RMHFL00-014Z03017000M06P04	☉	14	17	6.5	M6	3	—			
RMHFL00-015Z03017000M06P04	☉	15	17	6.5	M6	3	—			
RMHFL00-014Z03017000M08P04	☉	14	17	8.5	M8	3	—			
RMHFL00-015Z03017000M08P04	☉	15	17	8.5	M8	3	—			
RMHFL00-016Z04025000M08P04	☉	16	25	8.5	M8	4	—			
RMHFL00-017Z04025000M08P04	☉	17	25	8.5	M8	4	—			
RMHFL00-016Z02025000M08P06	☉	16	25	8.5	M8	2	—			
RMHFL00-016Z02025000M08P06-C	☉	16	25	8.5	M8	2	✓			
RMHFL00-017Z02025000M08P06	☉	17	25	8.5	M8	2	—			
RMHFL00-017Z02025000M08P06-C	☉	17	25	8.5	M8	2	✓			
RMHFL00-018Z02025000M08P06	☉	18	25	8.5	M8	2	—			
RMHFL00-020Z03029000M10P06	☉	20	29	10.5	M10	3	—			
RMHFL00-021Z03029000M10P06	☉	21	29	10.5	M10	3	—			
RMHFL00-022Z03029000M10P06	☉	22	29	10.5	M10	3	—			
RMHFL00-020Z03030000M10P06	☉	20	30	10.5	M10	3	—			
RMHFL00-020Z03030000M10P06-C	☉	20	30	10.5	M10	3	✓			
RMHFL00-021Z03030000M10P06	☉	21	30	10.5	M10	3	—			
RMHFL00-021Z03030000M10P06-C	☉	21	30	10.5	M10	3	✓			
RMHFL00-025Z04035000M12P06	☉	25	35	12.5	M12	4	—			
RMHFL00-025Z04035000M12P06-C	☉	25	35	12.5	M12	4	✓			
RMHFL00-026Z04035000M12P06	☉	26	35	12.5	M12	4	—			
RMHFL00-026Z04035000M12P06-C	☉	26	35	12.5	M12	4	✓			
RMHFL00-028Z05035000M12P06	☉	28	35	12.5	M12	5	—			
RMHFL00-032Z05038000M16P06	☉	32	38	16.5	M16	5	—			
RMHFL00-032Z05040000M16P06-C	☉	32	40	16.5	M16	5	✓			
RMHFL00-032Z04041000M16P06	☉	32	41	16.5	M16	4	—			
RMHFL00-032Z05043000M16P06	☉	32	43	16.5	M16	5	—			
RMHFL00-033Z05040000M16P06-C	☉	33	40	16.5	M16	5	✓			
RMHFL00-035Z06038000M16P06	☉	35	38	16.5	M16	6	—			
RMHFL00-035Z05043000M16P06	☉	35	43	16.5	M16	5	—			
RMHFL00-042Z06043000M16P06-C	☉	42	43	16.5	M16	6	✓			

Фрезы с другими характеристиками и геометрическими размерами изготавливаются по специальному заказу.

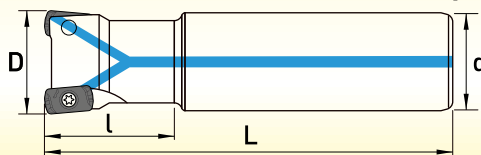

ФРЕЗЫ КОНЦЕВЫЕ С ЦИЛИНДРИЧЕСКИМ ХВОСТОВИКОМ ДЛЯ ВЫСОКИХ ПОДАЧ



Артикул	Статус	D мм	L мм	L мм	d мм	Z	Каналы СОЖ	Пластины	Винт	Ключ
RMHFL00-008Z01017100S10P04	☉	8	17	100	10	1	—	RHFL00MU-04X2...	SM1837	T06
RMHFL00-009Z01019100S10P04	☉	9	19	100	10	1	—			
RMHFL00-010Z02022100S10P04	☉	10	22	100	10	2	—			
RMHFL00-011Z02000100S10P04	☉	11	—	100	10	2	—			
RMHFL00-012Z03026080S12P04	☉	12	26	80	12	3	—			
RMHFL00-012Z03026120S12P04	☉	12	26	120	12	3	—			
RMHFL00-013Z03000080S12P04	☉	13	—	80	12	3	—			
RMHFL00-013Z03000120S12P04	☉	13	—	120	12	3	—			

ОКОНЧАНИЕ ТАБЛИЦЫ

Артикул	Статус	Д мм	Л мм	Л мм	д мм	Z	Каналы СОЖ	Пластины	Винт	Ключ
RMHFL00-014Z03030120S14P04	⊙	14	30	120	14	3	—	RHFL00MU-04X2...	SM1837	T06
RMHFL00-014Z03030150S14P04	⊙	14	30	150	14	3	—			
RMHFL00-015Z03000120S14P04	⊙	15	—	120	14	3	—			
RMHFL00-015Z03000160S14P04	⊙	15	—	160	14	3	—			
RMHFL00-016Z04035120S16P04	⊙	16	35	120	16	4	—			
RMHFL00-016Z04035160S16P04	⊙	16	35	160	16	4	—			
RMHFL00-017Z04000120S16P04	⊙	17	—	120	16	4	—			
RMHFL00-017Z04000160S16P04	⊙	17	—	160	16	4	—			
RMHFL00-016Z02025090S16P06	⊙	16	25	90	16	2	—			
RMHFL00-016Z02030100S16P06	⊙	16	30	100	16	2	—			
RMHFL00-016Z02030120S16P06	⊙	16	30	120	16	2	—			
RMHFL00-016Z02000150S15P06-C	⊙	16	—	150	15	2	✓			
RMHFL00-016Z02030150S16P06	⊙	16	30	150	16	2	—			
RMHFL00-016Z02030150S16P06-C	⊙	16	30	150	16	2	✓			
RMHFL00-016Z02040160S16P06-C	⊙	16	40	160	16	2	✓			
RMHFL00-017Z02000090S16P06	⊙	17	—	90	16	2	—			
RMHFL00-017Z02000100S16P06	⊙	17	—	100	16	2	—			
RMHFL00-017Z02000120S16P06	⊙	17	—	120	16	2	—			
RMHFL00-017Z02000150S16P06	⊙	17	—	150	16	2	—			
RMHFL00-018Z02000090S16P06	⊙	18	—	90	16	2	—			
RMHFL00-020Z03030100S20P06	⊙	20	30	100	20	3	—			
RMHFL00-020Z03050130S20P06	⊙	20	50	130	20	3	—			
RMHFL00-020Z04050130S20P06	⊙	20	50	130	20	4	—			
RMHFL00-020Z03050150S20P06	⊙	20	50	150	20	3	—			
RMHFL00-020Z03050150S20P06-C	⊙	20	50	150	20	3	✓			
RMHFL00-020Z03050160S20P06-C	⊙	20	50	160	20	3	✓			
RMHFL00-021Z03000100S20P06	⊙	21	—	100	20	3	—			
RMHFL00-021Z03000130S20P06	⊙	21	—	130	20	3	—			
RMHFL00-021Z03000150S20P06-C	⊙	21	—	150	20	3	✓			
RMHFL00-021Z03000160S20P06-C	⊙	21	—	160	20	3	✓			
RMHFL00-021Z03000200S20P06-C	⊙	21	—	200	20	3	✓			
RMHFL00-025Z04037100S25P06	⊙	25	37	100	25	4	—			
RMHFL00-025Z03040110S25P06	⊙	25	40	110	25	3	—			
RMHFL00-025Z04050150S25P06-C	⊙	25	50	150	25	4	✓			
RMHFL00-025Z04050160S25P06-C	⊙	25	50	160	25	4	✓			
RMHFL00-025Z04050200S25P06-C	⊙	25	50	200	25	4	✓			
RMHFL00-025Z04060140S25P06	⊙	25	60	140	25	4	—			
RMHFL00-025Z05060140S25P06	⊙	25	60	140	25	5	—			
RMHFL00-025Z04060150S25P06	⊙	25	60	150	25	4	—			
RMHFL00-025Z04060200S25P06	⊙	25	60	200	25	4	—			
RMHFL00-026Z04000110S25P06	⊙	26	—	110	25	4	—			
RMHFL00-026Z04000140S25P06	⊙	26	—	140	25	4	—			
RMHFL00-026Z04000160S25P06-C	⊙	26	—	160	25	4	✓			
RMHFL00-026Z04000200S25P06-C	⊙	26	—	200	25	4	✓			
RMHFL00-030Z04000150S25P06	⊙	30	—	150	25	4	—			
RMHFL00-032Z05050130S32P06	⊙	32	50	130	32	5	—			
RMHFL00-032Z05050160S32P06-C	⊙	32	50	160	32	5	✓			
RMHFL00-032Z05050200S32P06	⊙	32	50	200	32	5	—			
RMHFL00-032Z05050200S32P06-C	⊙	32	50	200	32	5	✓			
RMHFL00-032Z05070150S32P06	⊙	32	70	150	32	5	—			
RMHFL00-032Z06070150S32P06	⊙	32	70	150	32	6	—			
RMHFL00-032Z05070200S32P06	⊙	32	70	200	32	5	—			
RMHFL00-033Z05000150S32P06	⊙	33	—	150	32	5	—			
RMHFL00-033Z05000160S32P06-C	⊙	33	—	160	32	5	✓			
RMHFL00-033Z05000200S32P06-C	⊙	33	—	200	32	5	✓			
RMHFL00-035Z05000130S32P06	⊙	35	—	130	32	5	—			
RMHFL00-035Z05000160S32P06-C	⊙	35	—	160	32	5	✓			
RMHFL00-035Z06000160S32P06	⊙	35	—	160	32	6	—			
RMHFL00-035Z05000200S32P06	⊙	35	—	200	32	5	—			
RMHFL00-035Z05000200S32P06-C	⊙	35	—	200	32	5	✓			
RMHFL00-035Z06000200S32P06	⊙	35	—	200	32	6	—			

Фрезы с другими характеристиками и геометрическими размерами изготавливаются по специальному заказу.

⊙ — стандартная позиция; ○ — продукция изготавливается по спецзаказу потребителя, минимальная партия и сроки — по запросу.

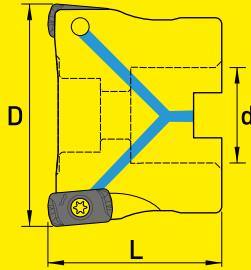

ФРЕЗЫ ТОРЦОВЫЕ НАСАДНЫЕ ДЛЯ ВЫСОКИХ ПОДАЧ



Артикул	Статус	D мм	L мм	d мм	Z	Каналы СОЖ	Пластины	Винт	Ключ
RMHFL00-032Z06040000D16P06	☉	32	40	16	6	—	RHFL00MU-06X4...	SM2560	T08
RMHFL00-032Z06040000D16P06-C	☉	32	40	16	6	✓			
RMHFL00-035Z06040000D16P06	☉	35	40	16	6	—			
RMHFL00-035Z06040000D16P06-C	☉	35	40	16	6	✓			
RMHFL00-040Z05040000D16P06	☉	40	40	16	5	—			
RMHFL00-040Z05040000D16P06-C	☉	40	40	16	5	✓			
RMHFL00-040Z06040000D16P06	☉	40	40	16	6	—			
RMHFL00-040Z06040000D16P06-C	☉	40	40	16	6	✓			
RMHFL00-045Z06040000D16P06	☉	45	40	16	6	—			
RMHFL00-045Z06040000D16P06-C	☉	45	40	16	6	✓			
RMHFL00-050Z08040000D22P06	☉	50	40	22	8	—			
RMHFL00-050Z08040000D22P06-C	☉	50	40	22	8	✓			
RMHFL00-050Z06050000D22P06	☉	50	50	22	6	—			
RMHFL00-050Z07050000D22P06-C	☉	50	50	22	7	✓			
RMHFL00-050Z08050000D22P06	☉	50	50	22	8	—			
RMHFL00-050Z08050000D22P06-C	☉	50	50	22	8	✓			
RMHFL00-055Z08040000D22P06	☉	55	40	22	8	—			
RMHFL00-055Z08040000D22P06-C	☉	55	40	22	8	✓			
RMHFL00-063Z08040000D22P06	☉	63	40	22	8	—			
RMHFL00-063Z08040000D22P06-C	☉	63	40	22	8	✓			
RMHFL00-063Z08050000D22P06	☉	63	50	22	8	—			
RMHFL00-063Z08050000D22P06-C	☉	63	50	22	8	✓			
RMHFL00-063Z09050000D22P06-C	☉	63	50	22	9	✓			
RMHFL00-070Z10040000D22P06	☉	70	40	22	10	—			
RMHFL00-070Z10040000D22P06-C	☉	70	40	22	10	✓			
RMHFL00-080Z10050000D27P06	☉	80	50	27	10	—			
RMHFL00-080Z10050000D27P06-C	☉	80	50	27	10	✓			

Фрезы с другими характеристиками и геометрическими размерами изготавливаются по специальному заказу.

ПЛАСТИНЫ ДЛЯ ФРЕЗ: ТИП RMHFL00

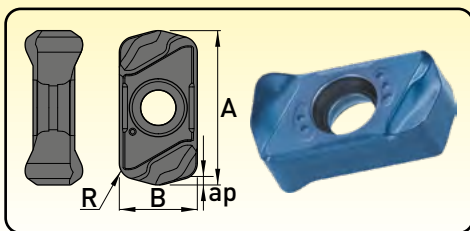

	P	M	K	N	S	H	С П Л А В Ы							
P	★	★	★	★	★	★	★	★	★	★	★	★	☆	☆
M	★	★	★	★	★	★	★	★	★	★	★	★	☆	☆
K			☆		★	★	★							
N														
S	★				★	★	★			★			★	★
H				★										

Артикул	A мм	B мм	ap max мм	R мм	fz мм/зуб	с покрытием										
						RMS30A	RU30	RMS30	RMT20	VPK25M	VM25	VS25	VM25M	ZSP20	ZSP20D	
RHFL00MU-04X2-MM	6.1	4.0	0.5	0.9	0.3-1.2											●
RHFL00MU-06X4-LM	10.2	6.0	1.0	1.2	0.3-1.3											●
RHFL00MU-06X4-MC						●	●	●	●							
RHFL00MU-06X4-DR										●	●	●	●			
RHFL00MU-06X4-MG										●	●	●	●			
RHFL00MU-06X4-JM										●	●	●	●			
RHFL00MU-06X4-SM										●	●	●	●			

РЕКОМЕНДОВАННЫЕ ЗНАЧЕНИЯ ПАРАМЕТРОВ РЕЗАНИЯ, ПРЕДСТАВЛЕННЫЕ В ТАБЛИЦЕ, ЯВЛЯЮТСЯ ОРИЕНТИРОВОЧНЫМИ И ДОЛЖНЫ ПРИМЕНЯТЬСЯ И КОРРЕКТИРОВАТЬСЯ В ЗАВИСИМОСТИ ОТ КОНКРЕТНЫХ УСЛОВИЙ ОБРАБОТКИ.

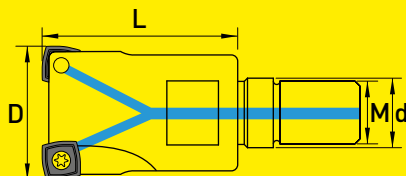

ГОЛОВКИ ФРЕЗЕРНЫЕ С РЕЗЬБОВЫМ ХВОСТОВИКОМ

Артикул	Статус	D мм	L мм	d мм	M	Z	Каналы СОЖ	Пластины	Винт	Ключ
RMHFS15-025Z03022000M12P09-C	⊙	25	22.5	12.5	M12	3	✓	RHFS15KT09...	SM3070	T10
RMHFS15-032Z04025000M12P09-C	⊙	32	25.0	17.0		4	✓			
RMHFS15-035Z04025000M16P09-C	⊙	35			4	✓				
RMHFS15-040Z05025000M16P09-C	⊙	40			5	✓				
RMHFS15-035Z03025000M16P12-C	⊙	35			M16	3	✓	RHFS15HT12... RHFS15MT12...	SM4090	T15
RMHFS15-040Z04025000M16P12-C	⊙	40	4	✓						

Фрезы с другими характеристиками и геометрическими размерами изготавливаются по специальному заказу.

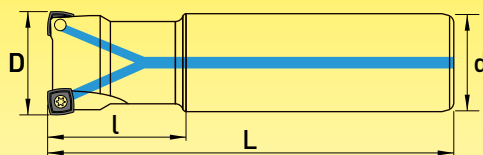

ФРЕЗЫ КОНЦЕВЫЕ С ЦИЛИНДРИЧЕСКИМ ХВОСТОВИКОМ

Артикул	Статус	D мм	L мм	L мм	d мм	Z	Каналы СОЖ	Пластины	Винт	Ключ
RMHFS15-025Z03040110S25P09-C	⊙	25	40	110	25	3	✓	RHFS15KT09...	SM3070	T10
RMHFS15-026Z03000110S25P09-C	⊙	26	—			3	✓			
RMHFS15-032Z04050130S32P09-C	⊙	32	50	130	32	4	✓			
RMHFS15-035Z04000130S32P09-C	⊙	35	—			4	✓			
RMHFS15-035Z04000200S32P09-C	⊙		—	200	4	✓				

Фрезы с другими характеристиками и геометрическими размерами изготавливаются по специальному заказу.

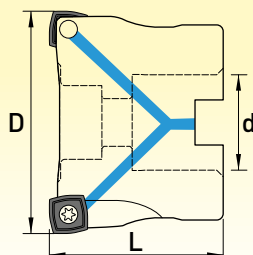

ФРЕЗЫ ТОРЦОВЫЕ НАСАДНЫЕ

Артикул	Статус	D мм	L мм	d мм	Z	Каналы СОЖ	Пластины	Винт	Ключ
RMHFS15-040Z04040000D16P09-C	⊙	40	40	16	4	✓	RHFS15KT09...	SM3070	T10
RMHFS15-050Z05040000D22P09-C	⊙	50	40	22	5	✓			
RMHFS15-063Z06040000D22P09-C	⊙	63	40	22	6	✓			
RMHFS15-063Z08040000D22P09-C	⊙	63	40	22	8	✓			
RMHFS15-080Z08040000D27P09-C	⊙	80	40	27	8	✓			
RMHFS15-050Z04050000D22P12	⊙	50	50	22	4	—	RHFS15HT12... RHFS15MT12...	SM4090	T15
RMHFS15-063Z05050000D22P12	⊙	63	50	22	5	—			
RMHFS15-080Z06050000D27P12	⊙	80	50	27	6	—			
RMHFS15-100Z06063000D32P12	⊙	100	63	32	6	—			
RMHFS15-125Z07063000D40P12	⊙	125	63	40	7	—			

Фрезы с другими характеристиками и геометрическими размерами изготавливаются по специальному заказу.

ПЛАСТИНЫ ДЛЯ ФРЕЗ: ТИП RMHFS15

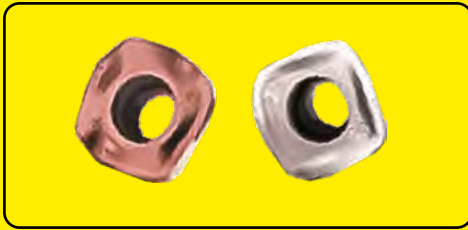

P	★	★	★		★		★
M	★	★	★	★		★	★
K			★		★		★
N							
S	★	★	★	★			
H							

С П Л А В Ы

с покрытием

Артикул	Rp* мм	ap max мм	fz мм/зуб	RMS30	RMS30A	RU30	RMT20	VPK25M	VM25M	VM25
RHFS15KT-09X308-MC	2	0.3-0.8	0.5-1.5	●	●	●	●			
RHFS15HT-120520-NF	4	0.5-1.2	0.8-1.5	●	●	●	●			
RHFS15HT-120520-NS		0.5-1.2	0.8-2.0	●	●	●	●			
RHFS15MT-120520-NS		0.5-1.2	0.8-2.0	●	●	●				
RHFS15MT-120512-MG		0.5-2.0	0.5-2.5					●	●	●
RHFS15MT-150512-MG		0.8-3.0	0.5-3.5					●		●

Rp* — программируемый радиус

РЕКОМЕНДОВАННЫЕ ЗНАЧЕНИЯ ПАРАМЕТРОВ РЕЗАНИЯ, ПРЕДСТАВЛЕННЫЕ В ТАБЛИЦЕ, ЯВЛЯЮТСЯ ОРИЕНТИРОВОЧНЫМИ И ДОЛЖНЫ ПРИМЕНЯТЬСЯ И КОРРЕКТИРОВАТЬСЯ В ЗАВИСИМОСТИ ОТ КОНКРЕТНЫХ УСЛОВИЙ ОБРАБОТКИ.

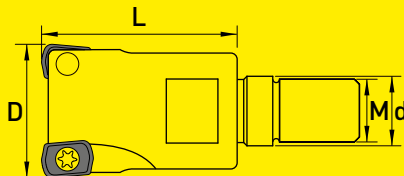

ГОЛОВКИ ФРЕЗЕРНЫЕ
С РЕЗЬБОВЫМ ХВОСТОВИКОМ

Артикул	Статус	D мм	L мм	d мм	M	Z	Пластины	Ключ
RMHFED-008Z01011000M04P04	⊙	8.0	11.5	4.5	M4	1	04 RMHF0515HT-0402-MC	T6
RMHFED-00AZ01011000M04P04	⊙	8.5	11.5	4.5	M4	1		
RMHFED-009Z01011000M04P04	⊙	9.0	11.5	4.5	M4	1		
RMHFED-00BZ01011000M04P04	⊙	9.5	11.5	4.5	M4	1		
RMHFED-010Z02012000M05P04	⊙	10.0	12.5	5.5	M5	2		
RMHFED-00CZ02012000M05P04	⊙	10.5	12.5	5.5	M5	2		
RMHFED-011Z02012000M05P04	⊙	11.0	12.5	5.5	M5	2		
RMHFED-00DZ02012000M05P04	⊙	11.5	12.5	5.5	M5	2		
RMHFED-012Z02012000M06P04	⊙	12.0	12.5	6.5	M6	2		
RMHFED-00EZ02012000M06P04	⊙	12.5	12.5	6.5	M6	2		
RMHFED-013Z02014000M06P04	⊙	13.0	14.0	6.5	M6	2		
RMHFED-00FZ02014000M06P04	⊙	13.5	14.0	6.5	M6	2		
RMHFED-014Z03014000M06P04	⊙	14.0	14.0	6.5	M6	3		
RMHFED-015Z04014000M06P04	⊙	15.0	14.0	6.5	M6	4		
RMHFED-016Z04016000M08P04	⊙	16.0	16.5	8.5	M8	4		

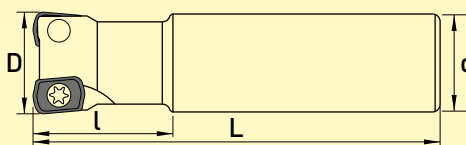

ФРЕЗЫ КОНЦЕВЫЕ
С ЦИЛИНДРИЧЕСКИМ ХВОСТОВИКОМ

Артикул	Статус	D мм	L мм	L мм	d мм	Z	Пластины	Ключ
RMHFED-008Z01016080S08P04	⊙	8	16	80	8	1	04 RMHF0515HT-0402-MC	T6
RMHFED-010Z02020080S10P04	⊙	10	20	80	10	2		
RMHFED-012Z02025090S12P04	⊙	12	25	90	12	2		
RMHFED-014Z03035100S16P04	⊙	14	35	100	16	3		
RMHFED-016Z04035100S16P04	⊙	16	35	100	16	4		

ПЛАСТИНЫ ДЛЯ ФРЕЗ: ТИП RMHFED



P	★	★	★	★
M	★	★	★	★
K		★	★	★
N				
S	★	★	★	★
H			★	

С П Л А В Ы
с покрытием

Артикул	ap max мм	fz мм/зуб	RMS30	RU30	RU15	RMT20
RMHF0515HT-0402-MC	0.15-0.4	0.2-0.5	●	●	●	●



ИНСТРУМЕНТАЛЬНЫЙ ЗАВОД
«ВОСХОД»

РАЗДЕЛ 6. ХВОСТОВИКИ ТВЕРДОСПЛАВНЫЕ

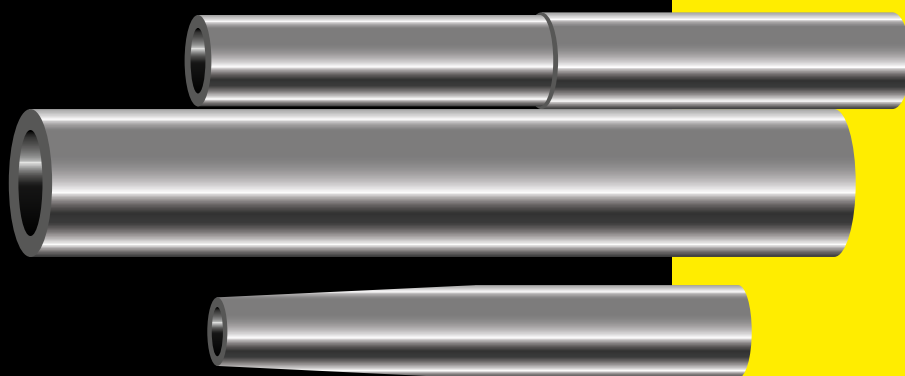

ХВОСТОВИКИ ЦИЛИНДРИЧЕСКИЕ ТВЕРДОСПЛАВНЫЕ С ОТВЕРСТИЕМ ДЛЯ СОЖ. ПРЕДНАЗНАЧЕНЫ ДЛЯ КРЕПЛЕНИЯ ИНСТРУМЕНТА С ХВОСТОВИКОМ С МЕТРИЧЕСКОЙ РЕЗЬБОЙ

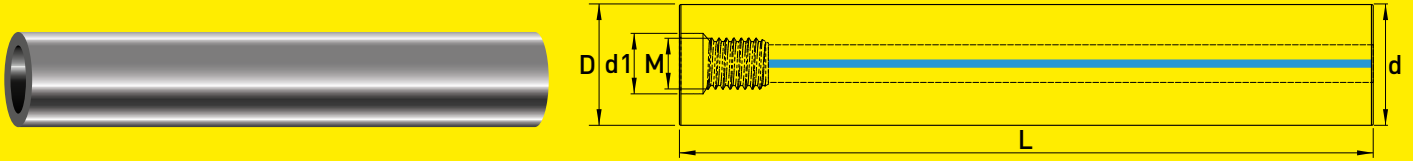

Артикул	Статус	D = d мм	d1 мм	M DIN 13	L мм
ТН001.М040810008-С	○	8	4.5	M4	100
ТН001.М051007510-С	○	10	5.5	M5	75
ТН001.М051010010-С	○	10	5.5	M5	100
ТН001.М051015010-С	○	10	5.5	M5	150
ТН001.М061010010-С	○	10	6.5	M6	100
ТН001.М061015010-С	○	10	6.5	M6	150
ТН001.М061110011-С	○	11	6.5	M6	100
ТН001.М061115011-С	○	11	6.5	M6	150
ТН001.М061207512-С	○	12	6.5	M6	75
ТН001.М061210012-С	○	12	6.5	M6	100
ТН001.М061215012-С	○	12	6.5	M6	150
ТН001.М061220012-С	○	12	6.5	M6	200
ТН001.М081510015-С	○	15	8.5	M8	100
ТН001.М081515015-С	○	15	8.5	M8	150
ТН001.М081520015-С	○	15	8.5	M8	200
ТН001.М081610016-С	○	16	8.5	M8	100
ТН001.М081615016-С	○	16	8.5	M8	150
ТН001.М081620016-С	○	16	8.5	M8	200
ТН001.М081625016-С	○	16	8.5	M8	250
ТН001.М081630016-С	○	16	8.5	M8	300
ТН001.М102010020-С	○	20	10.5	M10	100
ТН001.М102015020-С	○	20	10.5	M10	150
ТН001.М102020020-С	○	20	10.5	M10	200
ТН001.М102025020-С	○	20	10.5	M10	250
ТН001.М102030020-С	○	20	10.5	M10	300
ТН001.М102035020-С	○	20	10.5	M10	350
ТН001.М122510025-С	○	25	12.5	M12	100
ТН001.М122515025-С	○	25	12.5	M12	150
ТН001.М122520025-С	○	25	12.5	M12	200
ТН001.М122525025-С	○	25	12.5	M12	250
ТН001.М122530025-С	○	25	12.5	M12	300
ТН001.М122535025-С	○	25	12.5	M12	350
ТН001.М163210032-С	○	32	17.0	M16	100
ТН001.М163215032-С	○	32	17.0	M16	150
ТН001.М163220032-С	○	32	17.0	M16	200
ТН001.М163225032-С	○	32	17.0	M16	250
ТН001.М163230032-С	○	32	17.0	M16	300
ТН001.М163235032-С	○	32	17.0	M16	350
ТН001.М163240032-С	○	32	17.0	M16	400
ТН001.М163245032-С	○	32	17.0	M16	450
ТН001.М163250032-С	○	32	17.0	M16	500
ТН001.М163255032-С	○	32	17.0	M16	550

ХВОСТОВИКИ ТВЕРДОСПЛАВНЫЕ С ОБНИЖЕНИЕМ, С ОТВЕРСТИЕМ ДЛЯ СОЖ. ПРЕДНАЗНАЧЕНЫ ДЛЯ КРЕПЛЕНИЯ ИНСТРУМЕНТА С ХВОСТОВИКОМ С МЕТРИЧЕСКОЙ РЕЗЬБОЙ

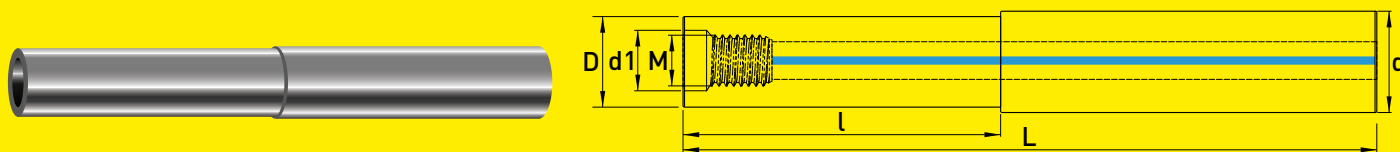

Артикул	Статус	D мм	d мм	d1 мм	M DIN 13	l мм	L мм
ТН042.М050910010.050-С	○	9.7	10	5.5	M5	50	100
ТН042.М050915010.080-С	○	9.7	10	5.5	M5	80	150
ТН042.М060910010.050-С	○	9.7	10	6.5	M6	50	100
ТН042.М060915010.080-С	○	9.7	10	6.5	M6	80	150
ТН042.М061110012.050-С	○	11.5	12	6.5	M6	50	100
ТН042.М061115012.090-С	○	11.5	12	6.5	M6	90	150
ТН042.М081510016.040-С	○	15.5	16	8.5	M8	40	100
ТН042.М081515016.090-С	○	15.5	16	8.5	M8	90	150
ТН042.М081520016.120-С	○	15.5	16	8.5	M8	120	200
ТН042.М101910020.040-С	○	19.5	20	10.5	M10	40	100
ТН042.М101915020.090-С	○	19.5	20	10.5	M10	90	150
ТН042.М101920020.140-С	○	19.5	20	10.5	M10	140	200
ТН042.М101925020.180-С	○	19.5	20	10.5	M10	180	250
ТН042.М101930020.230-С	○	19.5	20	10.5	M10	230	300
ТН042.М122410025.025-С	○	24.0	25	12.5	M12	25	100
ТН042.М122415025.070-С	○	24.0	25	12.5	M12	70	150
ТН042.М122420025.135-С	○	24.0	25	12.5	M12	135	200
ТН042.М122425025.180-С	○	24.0	25	12.5	M12	180	250
ТН042.М122430025.220-С	○	24.0	25	12.5	M12	220	300
ТН042.М162910032.030-С	○	29.0	32	17.0	M16	30	100
ТН042.М162915032.070-С	○	29.0	32	17.0	M16	70	150
ТН042.М162920032.120-С	○	29.0	32	17.0	M16	120	200
ТН042.М162925032.170-С	○	29.0	32	17.0	M16	170	250
ТН042.М162930032.220-С	○	29.0	32	17.0	M16	220	300
ТН042.М162935032.270-С	○	29.0	32	17.0	M16	270	350

ХВОСТОВИКИ ТВЕРДОСПЛАВНЫЕ С КОНИЧЕСКОЙ РАБОЧЕЙ ЧАСТЬЮ, С ОТВЕРСТИЕМ ДЛЯ СОЖ. ПРЕДНАЗНАЧЕНЫ ДЛЯ КРЕПЛЕНИЯ ИНСТРУМЕНТА С ХВОСТОВИКОМ С МЕТРИЧЕСКОЙ РЕЗЬБОЙ

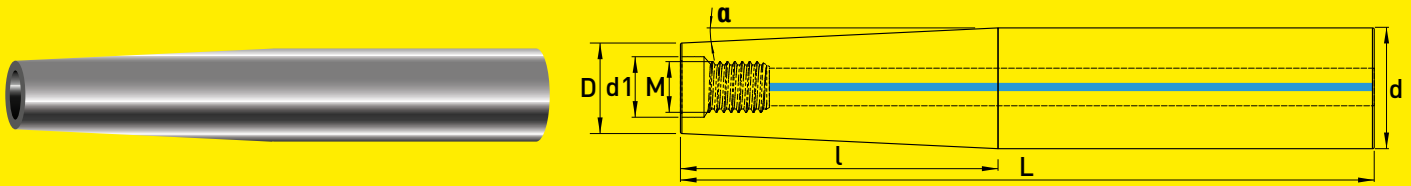

Артикул	Статус	D мм	d мм	d1 мм	M DIN 13	l мм	L мм	α
ТН043.М060910012.035-С	○	9.5	12	6.5	M6	35	100	1°30'
ТН043.М060915012.070-С	○	9.5	12	6.5	M6	70	150	1°45'
ТН043.М061115016.070-С	○	11.2	16	6.5	M6	70	150	1°45'
ТН043.М081410020.040-С	○	14.5	20	8.5	M8	40	100	3°30'
ТН043.М081415020.077-С	○	14.5	20	8.5	M8	77	150	1°45'
ТН043.М081520016.150-С	○	15.5	16	8.5	M8	150	200	0°43'
ТН043.М101810020.040-С	○	18.5	20	10.5	M10	40	100	0°43'
ТН043.М101815025.070-С	○	18.5	25	10.5	M10	70	150	1°43'
ТН043.М101815020.090-С	○	18.5	20	10.5	M10	90	150	0°19'
ТН043.М101820020.140-С	○	18.5	20	10.5	M10	140	200	0°12'
ТН043.М122320032.120-С	○	23.5	32	12.5	M12	120	200	1°45'
ТН043.М162920032.120-С	○	29.0	32	17.0	M16	120	200	0°30'
ТН043.М162925032.170-С	○	29.0	32	17.0	M16	170	250	0°28'
ТН043.М162930032.200-С	○	29.0	32	17.0	M16	200	300	0°28'

РАЗДЕЛ 7. ФРЕЗЫ ИЗ БЫСТРОРЕЖУЩИХ СТАЛЕЙ

МИНИФРЕЗЫ
СЕРИЯ MM42.015
ЦЕНТРОРЕЖУЩИЙ ЗУБ
ХВОСТОВИК WELDON
НОРМАЛЬНЫЕ И ДЛИННЫЕ
(ПЛОСКИЙ ТОРЕЦ)
МАТЕРИАЛ — P2M10K8



Рис. 1



Рис. 2

Артикул Рис. 1	Артикул Рис. 2	D, мм	l, мм	L, мм	d, мм	Z
MM42.015.01006S0000N	—	1.00	2	34	6	3
MM42.015.01506S0000N	—	1.50	3	34	6	3
—	MM42.015.01506S0000L	1.50	5	36	6	3
MM42.015.01806S0000N	—	1.80	3	34	6	3
MM42.015.02006S0000N	—	2.00	4	35	6	3
—	MM42.015.02006S0000L	2.00	7	38	6	3
MM42.015.02306S0000N	—	2.30	4	35	6	3
MM42.015.02506S0000N	—	2.50	5	36	6	3
—	MM42.015.02506S0000L	2.50	8	39	6	3
MM42.015.02806S0000N	—	2.80	5	36	6	3
MM42.015.03006S0000N	—	3.00	5	36	6	3
—	MM42.015.03006S0000L	3.00	8	39	6	3
MM42.015.03306S0000N	—	3.30	6	37	6	3
MM42.015.03506S0000N	—	3.50	6	37	6	3
—	MM42.015.03506S0000L	3.50	10	41	6	3
MM42.015.03806S0000N	—	3.80	7	38	6	3
MM42.015.04006S0000N	—	4.00	7	38	6	3
—	MM42.015.04006S0000L	4.00	11	42	6	3
MM42.015.04306S0000N	—	4.30	7	38	6	3
MM42.015.04506S0000N	—	4.50	7	38	6	3
—	MM42.015.04506S0000L	4.50	11	42	6	3
MM42.015.04806S0000N	—	4.80	8	39	6	3
MM42.015.05006S0000N	—	5.00	8	39	6	3
—	MM42.015.05006S0000L	5.00	13	44	6	3
MM42.015.05306S0000N	—	5.30	8	39	6	3
MM42.015.05506S0000N	—	5.50	8	39	6	3
—	MM42.015.05506S0000L	5.50	13	44	6	3
MM42.015.05706S0000N	—	5.75	8	39	6	3
MM42.015.06006S0000N	—	6.00	8	39	6	3
—	MM42.015.06006S0000L	6.00	13	44	6	3
MM42.015.06508S0000N	—	6.50	10	42	8	3
—	MM42.015.06508S0000L	6.50	16	48	8	3
MM42.015.07008S0000N	—	7.00	10	42	8	3
—	MM42.015.07008S0000L	7.00	16	48	8	3
MM42.015.07508S0000N	—	7.50	10	42	8	3
—	MM42.015.07508S0000L	7.50	16	48	8	3
MM42.015.08008S0000N	—	8.00	11	43	8	3
—	MM42.015.08008S0000L	8.00	19	51	8	3
MM42.015.08510S0000N	—	8.50	11	48	10	3
—	MM42.015.08510S0000L	8.50	19	56	10	3
MM42.015.09010S0000N	—	9.00	11	48	10	3
—	MM42.015.09010S0000L	9.00	19	56	10	3
MM42.015.09510S0000N	—	9.50	11	48	10	3
—	MM42.015.09510S0000L	9.50	19	56	10	3
MM42.015.10010S0000N	—	10.00	13	50	10	3
—	MM42.015.10010S0000L	10.00	22	59	10	3

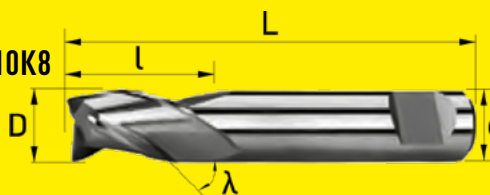

РЕКОМЕНДУЕМЫЕ РЕЖИМЫ РЕЗАНИЯ

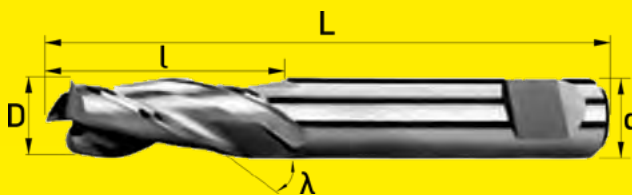
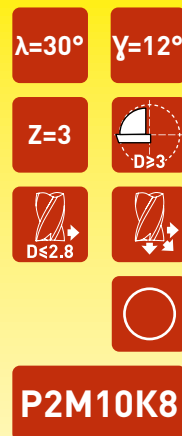
ISO	МАТЕРИАЛЫ	Предел кратковременной прочности на разрыв	a_p	a_e	Скорость резания V_c (м/мин)	Диаметры фрез					
						3	4	5	6	8	10
P	Автоматные и конструкционные стали	$\leq 600 \text{ N/mm}^2$	1xD	0,1xD	45	0,011	0,014	0,018	0,022	0,029	0,036
	Конструкционные и литые стали	$\leq 850 \text{ N/mm}^2$	1xD	0,1xD	39	0,010	0,013	0,017	0,020	0,026	0,033
	Инструментальные низколегированные стали	$\leq 1100 \text{ N/mm}^2$	1xD	0,1xD	24	0,008	0,011	0,014	0,016	0,022	0,027
	Улучшенные стали	$\leq 900 \text{ N/mm}^2$	1xD	0,1xD	30	0,008	0,011	0,014	0,016	0,022	0,027
	Инструментальные высоколегированные стали	$\leq 1100 \text{ N/mm}^2$	1xD	0,1xD	24	0,008	0,011	0,014	0,016	0,022	0,027
	Инструментальные и улучшенные стали	$\leq 1100 \text{ N/mm}^2$	1xD	0,1xD	20	0,008	0,011	0,014	0,016	0,022	0,027
M	Нержавеющие стали	750–850 N/mm^2	1xD	0,1xD	15	0,009	0,012	0,015	0,018	0,024	0,030
K	Чугуны	$\leq 820 \text{ N/mm}^2$ ($\leq 240 \text{ HB}$)	1xD	0,1xD	35	0,011	0,014	0,018	0,022	0,029	0,036
	Чугуны	$> 800 \text{ N/mm}^2$ ($> 240 \text{ HB}$)	1xD	0,1xD	25	0,010	0,013	0,017	0,020	0,026	0,033

РЕКОМЕНДОВАННЫЕ ЗНАЧЕНИЯ ПАРАМЕТРОВ РЕЗАНИЯ, ПРЕДСТАВЛЕННЫЕ В ТАБЛИЦЕ, ЯВЛЯЮТСЯ ОРИЕНТИРОВОЧНЫМИ И ДОЛЖНЫ ПРИМЕНЯТЬСЯ И КОРРЕКТИРОВАТЬСЯ В ЗАВИСИМОСТИ ОТ КОНКРЕТНЫХ УСЛОВИЙ ОБРАБОТКИ.

ФРЕЗЫ КОНЦЕВЫЕ СЕРИЯ MM35.024
ЦЕНТРОРЕЖУЩИЙ ЗУБ
ХВОСТОВИК ЦИЛИНДРИЧЕСКИЙ
НОРМАЛЬНЫЕ И ДЛИННЫЕ (ПЛОСКИЙ ТОРЕЦ)
МАТЕРИАЛ — P6M5K5



Рис. 1



Рис. 2

Артикул. Рис. 1	Артикул. Рис. 2	D, мм	d1, мм	l, мм	l1, мм	L, мм	d, мм	Z
MM35.024.02006S0000N	—	2.0	1.8	7	10	51	6	3
—	MM35.024.02006S0000L	2.0	1.8	10	13	42	6	3
MM35.024.02506S0000N	—	2.5	2.3	8	11	52	6	3
MM35.024.03006S0000N	—	3.0	2.8	11	18	44	6	3
—	MM35.024.03006S0000L	3.0	2.8	12	22	56	6	4
MM35.024.03506S0000N	—	3.5	3.3	10	19	54	6	4
—	MM35.024.03506S0000L	3.5	3.3	15	24	59	6	4
MM35.024.04006S0000N	—	4.0	3.8	11	21	55	6	4
—	MM35.024.04006S0000L	4.0	3.8	19	29	55	6	3
MM35.024.04506S0000N	—	4.5	4.3	11	21	55	6	4
—	MM35.024.04506S0000L	4.5	4.3	19	29	63	6	4
MM35.024.05006S0000N	—	5.0	4.8	13	21	57	6	4
—	MM35.024.05006S0000L	5.0	4.8	24	32	65	6	3
MM35.024.05506S0000N	—	5.5	5.3	13	21	57	6	4
—	MM35.024.05506S0000L	5.5	5.3	24	32	68	6	4
MM35.024.06006S0000N	—	6.0	5.5	13	21	57	6	4
—	MM35.024.06006S0000L	6.0	5.5	24	32	68	6	3
MM35.024.06510S0000N	—	6.5	6.0	16	21	66	10	4
MM35.024.07010S0000N	—	7.0	6.5	16	27	66	10	4
—	MM35.024.07010S0000L	7.0	6.5	30	41	80	10	4
MM35.024.07510S0000N	—	7.5	7.0	16	27	66	10	4
MM35.024.08010S0000N	—	8.0	7.5	19	27	69	10	4
—	MM35.024.08010S0000L	8.0	7.5	38	46	85	10	4
MM35.024.08510S0000N	—	8.5	8.0	19	27	69	10	4
MM35.024.09010S0000N	—	9.0	8.5	19	32	69	10	4
—	MM35.024.09010S0000L	9.0	8.5	38	51	88	10	4
MM35.024.09510S0000N	—	9.5	9.0	19	32	69	10	4
MM35.024.10010S0000N	—	10.0	9.5	22	32	72	10	4
—	MM35.024.10010S0000L	10.0	9.5	45	55	97	10	4
MM35.024.10012S0000N	—	11.0	10.5	22	38	79	12	4
—	MM35.024.11012S0000L	11.0	10.5	45	61	102	12	4
MM35.024.12012S0000N	—	12.0	11.5	26	38	83	12	4
—	MM35.024.12012S0000L	12.0	11.5	53	65	110	12	4
MM35.024.13012S0000N	—	13.0	—	26	—	83	12	4
—	MM35.024.13012S0000L	13.0	—	53	—	110	12	4
MM35.024.14012S0000N	—	14.0	—	26	—	83	12	4
—	MM35.024.14012S0000L	14.0	—	53	—	110	12	4
MM35.024.15012S0000N	—	15.0	—	26	—	83	12	4
—	MM35.024.15012S0000L	15.0	—	53	—	110	12	4
MM35.024.16016S0000N	—	16.0	15.5	32	44	92	16	4
—	MM35.024.16016S0000L	16.0	15.5	63	75	123	16	4

- λ=35°** **γ=8°**
- Z=3-6** **DIN 844**
- D>3**
- D≤2.5**
- P6M5K5**

**ФРЕЗЫ КОНЦЕВЫЕ СЕРИЯ MM35.024
ЦЕНТРОРЕЖУЩИЙ ЗУБ
ХВОСТОВИК ЦИЛИНДРИЧЕСКИЙ
НОРМАЛЬНЫЕ И ДЛИННЫЕ (ПЛОСКИЙ ТОРЕЦ)
МАТЕРИАЛ — P6M5K5**

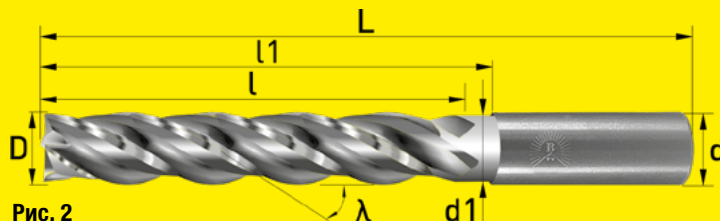

Рис. 1



Рис. 2

Окончание таблицы

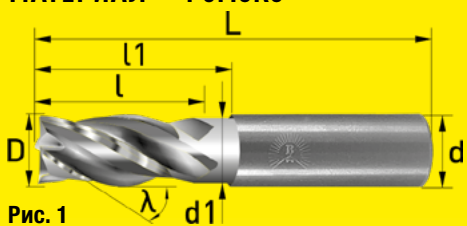
Артикул Рис. 1	Артикул Рис. 2	D, мм	d1, мм	l, мм	l1, мм	L, мм	d, мм	Z
MM35.024.17016S0000N	—	17.0	—	32	—	92	16	4
MM35.024.18016S0000N	—	18.0	—	32	—	92	16	4
—	MM35.024.18016S0000L	18.0	—	63	—	123	16	4
MM35.024.20020S0000N	—	20.0	19.5	38	54	104	20	4
—	MM35.024.20020S0000L	20.0	19.5	75	91	141	20	4
MM35.024.22020S0000N	—	22.0	—	38	—	104	20	5
—	MM35.024.22020S0000L	22.0	—	75	—	141	20	5
MM35.024.24025S0000N	—	24.0	23.5	45	65	121	25	5
—	MM35.024.24025S0000L	24.0	23.5	90	110	166	25	5
MM35.024.25025S0000N	—	25.0	24.5	45	65	121	25	5
—	MM35.024.25025S0000L	25.0	24.5	90	110	166	25	5
MM35.024.26025S0000N	—	26.0	—	45	—	121	25	5
—	MM35.024.26025S0000L	26.0	—	90	—	166	25	5
MM35.024.28025S0000N	—	28.0	—	45	—	121	25	5
—	MM35.024.28025S0000L	28.0	—	90	—	166	25	5
MM35.024.30025S0000N	—	30.0	—	45	—	121	25	5
—	MM35.024.30025S0000L	30.0	—	90	—	166	25	5
MM35.024.32032S0000N	—	32.0	31.5	53	73	133	32	6
—	MM35.024.32032S0000L	32.0	31.5	106	126	186	32	6
MM35.024.35032S0000N	—	35.0	—	53	—	133	32	6
MM35.024.36032S0000N	—	36.0	—	53	—	133	32	6
—	MM35.024.36032S0000L	36.0	—	106	—	186	32	6
MM35.024.40032S0000N	—	40.0	—	63	—	143	32	6
—	MM35.024.40032S0000L	40.0	—	125	—	205	32	6

$\lambda=35^\circ$ $\gamma=8^\circ$

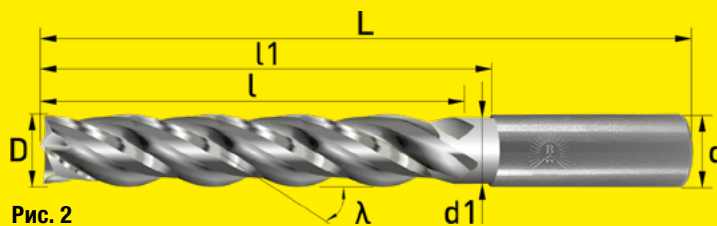
Z=3-6 DIN 844



P6M5K5

РЕКОМЕНДУЕМЫЕ РЕЖИМЫ РЕЗАНИЯ

ISO	МАТЕРИАЛЫ	Предел кратковременной прочности на разрыв	a _p	a _e	Скорость резания V _c (м/мин)	Диаметры фрез										
						3	6	8	10	12	16	18	20	25	32	40
P	Автоматные и конструкционные стали	≤ 600 N/mm ²	1xD	0,1xD	45	0,006	0,015	0,021	0,028	0,034	0,044	0,051	0,057	0,071	0,091	0,110
	Конструкционные и литые стали	≤ 850 N/mm ²	1xD	0,1xD	39	0,006	0,015	0,021	0,028	0,034	0,044	0,051	0,057	0,071	0,091	0,110
	Инструментальные низколегированные стали	≤ 1100 N/mm ²	1xD	0,1xD	24	0,006	0,015	0,021	0,028	0,034	0,044	0,051	0,057	0,071	0,091	0,110
	Улучшенные стали	≤ 900 N/mm ²	1xD	0,1xD	30	0,006	0,015	0,021	0,028	0,034	0,044	0,051	0,057	0,071	0,091	0,110
M	Нержавеющие стали	750-850 N/mm ²	1xD	0,1xD	15	0,004	0,011	0,015	0,020	0,024	0,031	0,036	0,040	0,050	0,064	0,077
						0,004	0,011	0,015	0,020	0,024	0,031	0,036	0,040	0,050	0,064	0,077
K	Чугуны	> 800 N/mm ² (> 240 HB)	1xD	0,1xD	35	0,006	0,015	0,021	0,028	0,034	0,044	0,051	0,057	0,071	0,091	0,110
N	Алюминий-кремниевые сплавы	≤ 600 N/mm ²	1xD	0,1xD	160-300	0,008	0,020	0,027	0,036	0,044	0,060	0,066	0,074	0,092	0,118	0,143
S	Хромникелевые сплавы	≤ 1500 N/mm ²	1xD	0,1xD	12	0,004	0,011	0,015	0,020	0,024	0,031	0,036	0,040	0,050	0,064	0,077

РЕКОМЕНДОВАННЫЕ ЗНАЧЕНИЯ ПАРАМЕТРОВ РЕЗАНИЯ, ПРЕДСТАВЛЕННЫЕ В ТАБЛИЦЕ, ЯВЛЯЮТСЯ ОРИЕНТИРОВОЧНЫМИ И ДОЛЖНЫ ПРИМЕНЯТЬСЯ И КОРРЕКТИРОВАТЬСЯ В ЗАВИСИМОСТИ ОТ КОНКРЕТНЫХ УСЛОВИЙ ОБРАБОТКИ.

ФРЕЗЫ КОНЦЕВЫЕ СЕРИЯ MM42.014
ЦЕНТРОРЕЖУЩИЙ ЗУБ
ХВОСТОВИК WELDON
НОРМАЛЬНЫЕ И ДЛИННЫЕ (ПЛОСКИЙ ТОРЕЦ)
МАТЕРИАЛ — P2M10K8

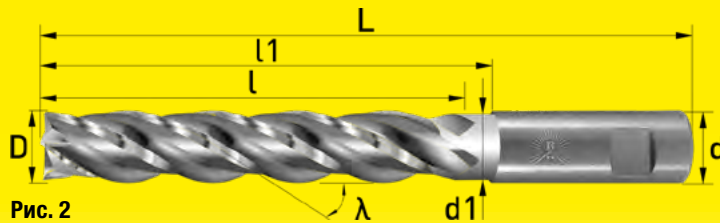
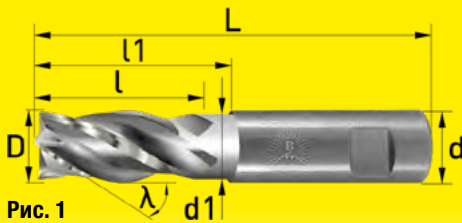

Артикул. Рис. 1	Артикул. Рис. 2	D, мм	d1, мм	l, мм	l1, мм	L, мм	d, мм	Z
MM42.014.02006S0000N	—	2.0	1.8	7	10	51	6	3
—	MM42.014.02006S0000L	2.0	1.8	10	13	54	6	3
MM42.014.02506S0000N	—	2.5	2.3	8	11	52	6	3
MM42.014.03006S0000N	—	3.0	2.8	8	18	52	6	4
—	MM42.014.03006S0000L	3.0	2.8	12	22	56	6	4
MM42.014.03506S0000N	—	3.5	3.3	10	19	54	6	4
—	MM42.014.03506S0000L	3.5	3.3	15	24	59	6	4
MM42.014.04006S0000N	—	4.0	3.8	11	21	55	6	4
—	MM42.014.04006S0000L	4.0	3.8	19	29	63	6	4
MM42.014.04506S0000N	—	4.5	4.3	11	21	55	6	4
—	MM42.014.04506S0000L	4.5	4.3	19	29	63	6	4
MM42.014.05006S0000N	—	5.0	4.8	13	21	57	6	4
—	MM42.014.05006S0000L	5.0	4.8	24	32	68	6	4
MM42.014.05506S0000N	—	5.5	5.3	13	21	57	6	4
—	MM42.014.05506S0000L	5.5	5.3	24	32	68	6	4
MM42.014.06006S0000N	—	6.0	5.5	13	21	57	6	4
—	MM42.014.06006S0000L	6.0	5.5	24	32	68	6	4
MM42.014.06510S0000N	—	6.5	6.0	16	21	66	10	4
MM42.014.07010S0000N	—	7.0	6.5	16	27	66	10	4
—	MM42.014.07010S0000L	7.0	6.5	30	41	80	10	4
MM42.014.07510S0000N	—	7.5	7.0	16	27	66	10	4
MM42.014.08010S0000N	—	8.0	7.5	19	27	69	10	4
—	MM42.014.08010S0000L	8.0	7.5	38	46	88	10	4
MM42.014.08510S0000N	—	8.5	8.0	19	27	69	10	4
MM42.014.09010S0000N	—	9.0	8.5	19	32	69	10	4
—	MM42.014.09010S0000L	9.0	8.5	38	51	88	10	4
MM42.014.09510S0000N	—	9.5	9.0	19	32	69	10	4
MM42.014.10010S0000N	—	10.0	9.5	22	32	72	10	4
—	MM42.014.10010S0000L	10.0	9.5	45	55	95	10	4
MM42.014.10012S0000N	—	11.0	10.5	22	38	79	12	4
—	MM42.014.11012S0000L	11.0	10.5	45	61	102	12	4
MM42.014.12012S0000N	—	12.0	11.5	26	38	83	12	4
—	MM42.014.12012S0000L	12.0	11.5	53	65	110	12	4
MM42.014.13012S0000N	—	13.0	—	26	—	83	12	4
—	MM42.014.13012S0000L	13.0	—	53	—	110	12	4
MM42.014.14012S0000N	—	14.0	—	26	—	83	12	4
—	MM42.014.14012S0000L	14.0	—	53	—	110	12	4
MM42.014.15012S0000N	—	15.0	—	26	—	83	12	4
—	MM42.014.15012S0000L	15.0	—	53	—	110	12	4
MM42.014.16016S0000N	—	16.0	15.5	32	44	92	16	4
—	MM42.014.16016S0000L	16.0	15.5	63	75	123	16	4

$\lambda=30^\circ$ $\gamma=8^\circ$

Z=3-6 DIN 844

$D \leq 2.5$ $D > 3$

P2M10K8

ФРЕЗЫ КОНЦЕВЫЕ СЕРИЯ MM42.014
ЦЕНТРОРЕЖУЩИЙ ЗУБ
ХВОСТОВИК WELDON
НОРМАЛЬНЫЕ И ДЛИННЫЕ (ПЛОСКИЙ ТОРЕЦ)
МАТЕРИАЛ — P2M10K8



Рис. 1



Рис. 2

Окончание таблицы

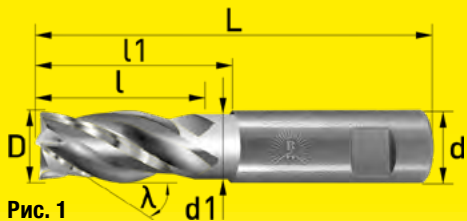
Артикул Рис. 1	Артикул Рис. 2	D, мм	d1, мм	l, мм	l1, мм	L, мм	d, мм	Z
MM42.014.17016S0000N	—	17.0	—	32	—	92	16	4
MM42.014.18016S0000N	—	18.0	—	32	—	92	16	4
—	MM42.014.18016S0000L	18.0	—	63	—	123	16	4
MM42.014.20020S0000N	—	20.0	19.5	38	54	104	20	4
—	MM42.014.20020S0000L	20.0	19.5	75	91	141	20	4
MM42.014.22020S0000N	—	22.0	—	38	—	104	20	5
—	MM42.014.22020S0000L	22.0	—	75	—	141	20	5
MM42.014.24025S0000N	—	24.0	23.5	45	65	121	25	5
—	MM42.014.24025S0000L	24.0	23.5	90	110	166	25	5
MM42.014.25025S0000N	—	25.0	24.5	45	65	121	25	5
—	MM42.014.25025S0000L	25.0	24.5	90	110	166	25	5
MM42.014.26025S0000N	—	26.0	—	45	—	121	25	5
—	MM42.014.26025S0000L	26.0	—	90	—	166	25	5
MM42.014.28025S0000N	—	28.0	—	45	—	121	25	5
—	MM42.014.28025S0000L	28.0	—	90	—	166	25	5
MM42.014.30025S0000N	—	30.0	—	45	—	121	25	5
—	MM42.014.30025S0000L	30.0	—	90	—	166	25	5
MM42.014.32032S0000N	—	32.0	31.5	53	73	133	32	6
—	MM42.014.32032S0000L	32.0	31.5	106	126	186	32	6
MM42.014.35032S0000N	—	35.0	—	53	—	133	32	6
MM42.014.36032S0000N	—	36.0	—	53	—	133	32	6
—	MM42.014.36032S0000L	36.0	—	106	—	186	32	6
MM42.014.40032S0000N	—	40.0	—	63	—	143	32	6
—	MM42.014.40032S0000L	40.0	—	125	—	205	32	6

$\lambda=30^\circ$ $\gamma=8^\circ$

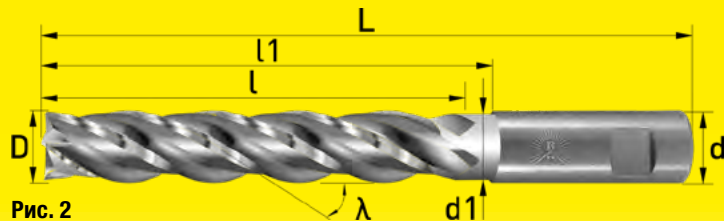
Z=3-6 DIN 844

$D \geq 3$

$D \leq 2.5$

P2M10K8

РЕКОМЕНДУЕМЫЕ РЕЖИМЫ РЕЗАНИЯ

ISO	МАТЕРИАЛЫ	Предел кратковременной прочности на разрыв	a _p	a _e	Скорость резания V _c (м/мин)	Диаметры фрез										
						3	6	8	10	12	16	18	20	25	32	40
P	Автоматные и конструкционные стали	≤ 600 N/mm ²	1xD	0,1xD	45	0,006	0,015	0,021	0,028	0,034	0,044	0,051	0,057	0,071	0,091	0,110
	Конструкционные и литые стали	≤ 850 N/mm ²	1xD	0,1xD	39	0,006	0,015	0,021	0,028	0,034	0,044	0,051	0,057	0,071	0,091	0,110
	Инструментальные низколегированные стали	≤ 1100 N/mm ²	1xD	0,1xD	24	0,006	0,015	0,021	0,028	0,034	0,044	0,051	0,057	0,071	0,091	0,110
	Улучшенные стали	≤ 900 N/mm ²	1xD	0,1xD	30	0,006	0,015	0,021	0,028	0,034	0,044	0,051	0,057	0,071	0,091	0,110
	Инструментальные и улучшенные стали	≤ 1100 N/mm ²	1xD	0,1xD	20	0,004	0,011	0,015	0,020	0,024	0,031	0,036	0,040	0,050	0,064	0,077
M	Нержавеющие стали	750-850 N/mm ²	1xD	0,1xD	15	0,006	0,015	0,021	0,028	0,034	0,044	0,051	0,057	0,071	0,091	0,110
K	Чугуны	> 800 N/mm ² (> 240 HB)	1xD	0,1xD	35	0,006	0,015	0,021	0,028	0,034	0,044	0,051	0,057	0,071	0,091	0,110
N	Алюминий-кремниевые сплавы	≤ 600 N/mm ²	1xD	0,1xD	160-300	0,008	0,020	0,027	0,036	0,044	0,060	0,066	0,074	0,092	0,118	0,143
S	Хромоникелевые сплавы	≤ 1500 N/mm ²	1xD	0,1xD	12	0,004	0,011	0,015	0,020	0,024	0,031	0,036	0,040	0,050	0,064	0,077

РЕКОМЕНДОВАННЫЕ ЗНАЧЕНИЯ ПАРАМЕТРОВ РЕЗАНИЯ, ПРЕДСТАВЛЕННЫЕ В ТАБЛИЦЕ, ЯВЛЯЮТСЯ ОРИЕНТИРОВОЧНЫМИ И ДОЛЖНЫ ПРИМЕНЯТЬСЯ И КОРРЕКТИРОВАТЬСЯ В ЗАВИСИМОСТИ ОТ КОНКРЕТНЫХ УСЛОВИЙ ОБРАБОТКИ.

ВЫСОКОПРОИЗВОДИТЕЛЬНЫЕ ЧЕРНОВЫЕ ФРЕЗЫ
СЕРИЯ MRM42.017
СТРУЖКОЛОМАЮЩИЕ КАНАВКИ
ЦЕНТРОРЕЖУЩИЙ ЗУБ
ХВОСТОВИК WELDON
(ПЛОСКИЙ ТОРЕЦ)
МАТЕРИАЛ — P2M10K8



Рис. 1



Рис. 2

Артикул. Рис. 1	Артикул. Рис. 2	D, мм	d1, мм	l, мм	l1, мм	L, мм	d, мм	Z
MRM42.017.06006S0000N		6	5.5	13	21	57	6	4
	MRM42.017.06006S0000L	6	5.5	24	32	68	6	4
MRM42.017.07010S0000N		7	6.5	16	27	66	10	4
	MRM42.017.07010S0000L	7	6.5	30	41	80	10	4
MRM42.017.08010S0000N		8	7.5	19	27	69	10	4
	MRM42.017.08010S0000L	8	7.5	38	46	88	10	4
MRM42.017.09010S0000N		9	8.5	19	32	69	10	4
	MRM42.017.09010S0000L	9	8.5	38	51	88	10	4
MRM42.017.10010S0000N		10	9.5	22	32	72	10	4
	MRM42.017.10010S0000L	10	9.5	45	55	95	10	4
MRM42.017.11012S0000N		11	10.5	22	38	79	12	4
	MRM42.017.11012S0000L	11	10.5	45	61	102	12	4
MRM42.017.12012S0000N		12	11.5	26	38	83	12	4
	MRM42.017.12012S0000L	12	11.5	53	65	110	12	4
MRM42.017.13012S0000N		13	—	26	—	83	12	4
MRM42.017.14012S0000N		14	—	26	—	83	12	4
	MRM42.017.14012S0000L	14	—	53	—	110	12	4
MRM42.017.15012S0000N		15	—	26	—	83	12	4
	MRM42.017.15012S0000L	15	—	53	—	110	12	4
MRM42.017.16016S0000N		16	15.5	32	44	92	16	4
	MRM42.017.16016S0000L	16	15.5	63	75	123	16	4
MRM42.017.17016S0000N		17	—	32	—	92	16	4
MRM42.017.18016S0000N		18	—	32	—	92	16	4
	MRM42.017.18016S0000L	18	—	63	—	123	16	4
MRM42.017.19016S0000N		19	—	32	—	92	16	4
MRM42.017.20020S0000N		20	19.5	38	54	104	20	4
	MRM42.017.20020S0000L	20	19.5	75	91	141	20	4
MRM42.017.21020S0000N		21	—	38	—	104	20	4
MRM42.017.22020S0000N	MRM42.017.22020S0000L	22	—	38	—	104	20	5
		22	—	75	—	141	20	5
MRM42.017.24025S0000N		24	23.5	45	65	121	25	5
	MRM42.017.24025S0000L	24	23.5	90	110	166	25	5
MRM42.017.25025S0000N		25	24.5	45	65	121	25	5
	MRM42.017.25025S0000L	25	24.5	90	110	166	25	5

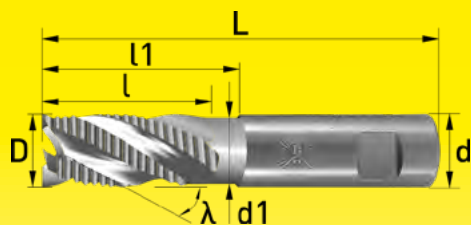

ВЫСОКОПРОИЗВОДИТЕЛЬНЫЕ ЧЕРНОВЫЕ ФРЕЗЫ
СЕРИЯ MRM42.017
СТРУЖКОЛОМАЮЩИЕ КАНАВКИ
ЦЕНТРОРЕЖУЩИЙ ЗУБ
ХВОСТОВИК WELDON
(ПЛОСКИЙ ТОРЕЦ)
МАТЕРИАЛ — P2M10K8

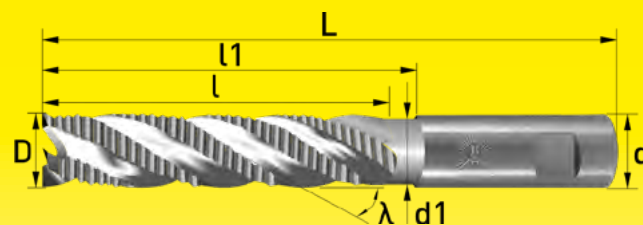

Рис. 1



Рис. 2

Окончание таблицы

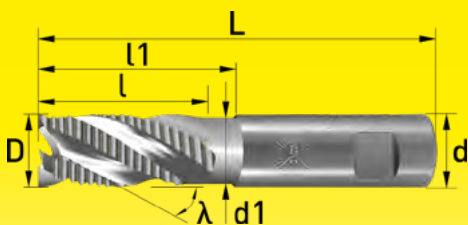
Артикул. Рис. 1	Артикул. Рис. 2	D, мм	d1, мм	l, мм	l1, мм	L, мм	d, мм	Z
MRM42.017.26025S0000N		26	—	45	—	121	25	5
	MRM42.017.26025S0000L	26	—	90	—	166	25	5
MRM42.017.28025S0000N		28	—	45	—	121	25	5
	MRM42.017.28025S0000L	28	—	90	—	166	25	5
MRM42.017.30025S0000N		30	—	45	—	121	25	5
	MRM42.017.30025S0000L	30	—	90	—	166	25	5
MRM42.017.32032S0000N		32	31.5	53	73	133	32	6
	MRM42.017.32032S0000L	32	31.5	106	126	186	32	6
MRM42.017.36032S0000N		36	—	53	—	133	32	6
	MRM42.017.36032S0000L	36	—	106	—	186	32	6
MRM42.017.40032S0000N		40	—	63	—	143	32	6
	MRM42.017.40032S0000L	40	—	125	—	205	32	6

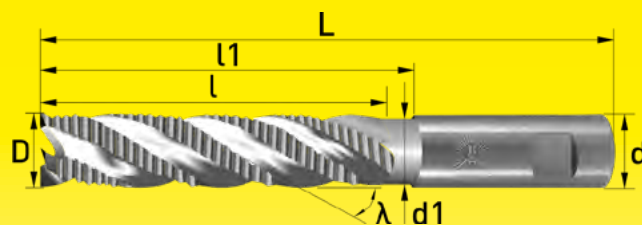

РЕКОМЕНДУЕМЫЕ РЕЖИМЫ РЕЗАНИЯ

ISO	МАТЕРИАЛЫ	Предел кратковременной прочности на разрыв	a _p	a _e	Скорость резания V _c (м/мин)	Диаметры фрез									
						6	8	10	12	16	18	20	25	30	40
P	Автоматные и конструкционные стали	≤ 600 N/mm ²	1.5xD	0.5xD	45	0.02	0.025	0.035	0.04	0.07	0.08	0.09	0.1	0.115	0.14
	Конструкционные и литые стали	≤ 850 N/mm ²	1.5xD	0.5xD	39	0.02	0.025	0.035	0.04	0.07	0.08	0.09	0.1	0.115	0.14
	Улучшенные стали	≤ 900 N/mm ²	1.5xD	0.5xD	30	0.02	0.025	0.035	0.04	0.07	0.08	0.09	0.1	0.115	0.14
M	Нержавеющие стали	750–850 N/mm ²	1.5xD	0.5xD	15	0.02	0.025	0.035	0.04	0.07	0.08	0.09	0.1	0.115	0.14
K	Чугуны	≤ 820 N/mm ² (≤ 240 HB)	1.5xD	0.5xD	35	0.02	0.025	0.035	0.04	0.07	0.08	0.09	0.1	0.115	0.14

РЕКОМЕНДОВАННЫЕ ЗНАЧЕНИЯ ПАРАМЕТРОВ РЕЗАНИЯ, ПРЕДСТАВЛЕННЫЕ В ТАБЛИЦЕ, ЯВЛЯЮТСЯ ОРИЕНТИРОВОЧНЫМИ И ДОЛЖНЫ ПРИМЕНЯТЬСЯ И КОРРЕКТИРОВАТЬСЯ В ЗАВИСИМОСТИ ОТ КОНКРЕТНЫХ УСЛОВИЙ ОБРАБОТКИ.

ФРЕЗЫ КОНЦЕВЫЕ
СЕРИИ MM42.016/MM42.018
ЦЕНТРОРЕЖУЩИЙ ЗУБ
ХВОСТОВИК WELDON
(ПЛОСКИЙ ТОРЕЦ)
МАТЕРИАЛ — P2M10K8



Рис. 1



Рис. 2

Артикул. Рис. 1	Артикул. Рис. 2. TiAlN	D, мм	d1, мм	l, мм	l1, мм	L, мм	d, мм	Z
MM42.016.02006S0000N	MM42.018.02006S0000N	2.0	1.8	7	10	51	6	3
MM42.016.02506S0000N	MM42.018.02506S0000N	2.5	2.3	8	11	52	6	3
MM42.016.03006S0000N	MM42.018.03006S0000N	3.0	2.8	8	18	52	6	3
MM42.016.03506S0000N	MM42.018.03506S0000N	3.5	3.3	10	19	54	6	3
MM42.016.04006S0000N	MM42.018.04006S0000N	4.0	3.8	11	21	55	6	3
MM42.016.04506S0000N	MM42.018.04506S0000N	4.5	4.3	11	21	55	6	3
MM42.016.05006S0000N	MM42.018.05006S0000N	5.0	4.8	13	21	57	6	3
MM42.016.06006S0000N	MM42.018.06006S0000N	6.0	5.5	13	21	57	6	3
MM42.016.07010S0000N	MM42.018.07010S0000N	7.0	6.5	16	27	66	10	3
MM42.016.08010S0000N	MM42.018.08010S0000N	8.0	7.5	19	27	69	10	3
MM42.016.09010S0000N	MM42.018.09010S0000N	9.0	8.5	19	32	69	10	3
MM42.016.10010S0000N	MM42.018.10010S0000N	10.0	9.5	22	32	72	10	3
MM42.016.11012S0000N	MM42.018.11012S0000N	11.0	10.5	22	38	79	12	3
MM42.016.12012S0000N	MM42.018.12012S0000N	12.0	11.5	26	38	83	12	3
MM42.016.13012S0000N	MM42.018.13012S0000N	13.0	—	26	—	83	12	3
MM42.016.14012S0000N	MM42.018.14012S0000N	14.0	—	26	—	83	12	3
MM42.016.15012S0000N	MM42.018.15012S0000N	15.0	—	26	—	83	12	3
MM42.016.16016S0000N	MM42.018.16016S0000N	16.0	15.5	32	44	92	16	3
MM42.016.17016S0000N	MM42.018.17016S0000N	17.0	—	32	—	92	16	3
MM42.016.18016S0000N	MM42.018.18016S0000N	18.0	—	32	—	92	16	3
MM42.016.19016S0000N	MM42.018.19016S0000N	19.0	—	32	—	92	16	3
MM42.016.20020S0000N	MM42.018.20020S0000N	20.0	19.5	38	54	104	20	3
MM42.016.22020S0000N	MM42.018.22020S0000N	22.0	—	38	—	104	20	3
MM42.016.25025S0000N	MM42.018.25025S0000N	25.0	24.5	45	65	121	25	3
MM42.016.28025S0000N	MM42.018.28025S0000N	28.0	—	45	—	121	25	3
MM42.016.32032S0000N	MM42.018.32032S0000N	32.0	31.5	53	73	133	32	3

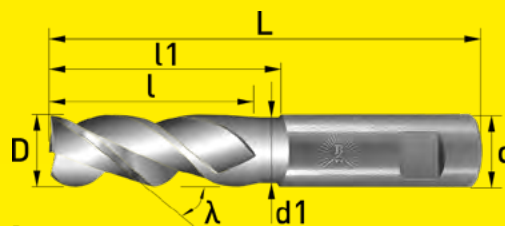
$\lambda=40^\circ$ $\gamma=12^\circ$

Z=3 DIN 844

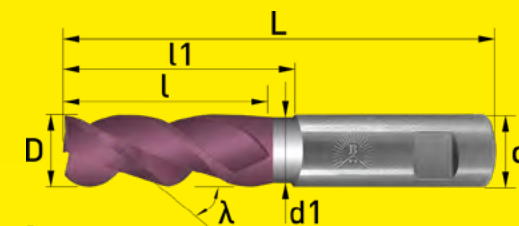
$D \geq 3$

TiAlN

P2M10K8

РЕКОМЕНДУЕМЫЕ РЕЖИМЫ РЕЗАНИЯ

ISO	МАТЕРИАЛЫ	Предел кратковременной прочности на разрыв	a _p	a _e	Скорость резания V _c (м/мин)	Диаметры фрез										
						3	6	8	10	12	16	18	20	25	32	
P	Автоматные и конструкционные стали	≤ 600 N/mm ²	1xD	0,1xD	45	0,006	0,015	0,021	0,028	0,034	0,044	0,051	0,057	0,10	0,120	
	Конструкционные и литые стали	≤ 850 N/mm ²	1xD	0,1xD	39	0,006	0,015	0,021	0,028	0,034	0,044	0,051	0,057	0,10	0,120	
P	Инструментальные низколегированные стали	≤ 1100 N/mm ²	1xD	0,1xD	24	0,006	0,015	0,021	0,028	0,034	0,044	0,051	0,057	0,10	0,120	
	Улучшенные стали	≤ 900 N/mm ²	1xD	0,1xD	30	0,006	0,015	0,021	0,028	0,034	0,044	0,051	0,057	0,10	0,120	
K	Инструментальные высоколегированные стали	≤ 1100 N/mm ²	1xD	0,1xD	24	0,006	0,015	0,021	0,028	0,034	0,044	0,051	0,057	0,10	0,120	
	Чугуны	≤ 820 N/mm ² (≤ 240 HB)	1xD	0,1xD	35	0,006	0,015	0,021	0,028	0,034	0,044	0,051	0,057	0,10	0,120	
N	Медноцинковые и меднооловянные сплавы	≤ 800 N/mm ²	1xD	0,1xD	80–120	0,006	0,015	0,021	0,028	0,034	0,044	0,051	0,057	0,10	0,120	
S	Хромоникелевые сплавы	≤ 1500 N/mm ²	1xD	0,1xD	12	0,004	0,011	0,015	0,020	0,024	0,031	0,036	0,040	0,07	0,084	

РЕКОМЕНДОВАННЫЕ ЗНАЧЕНИЯ ПАРАМЕТРОВ РЕЗАНИЯ, ПРЕДСТАВЛЕННЫЕ В ТАБЛИЦЕ, ЯВЛЯЮТСЯ ОРИЕНТИРОВОЧНЫМИ И ДОЛЖНЫ ПРИМЕНЯТЬСЯ И КОРРЕКТИРОВАТЬСЯ В ЗАВИСИМОСТИ ОТ КОНКРЕТНЫХ УСЛОВИЙ ОБРАБОТКИ.

РАЗДЕЛ 8. БОРФРЕЗЫ



СИСТЕМА ОБОЗНАЧЕНИЙ

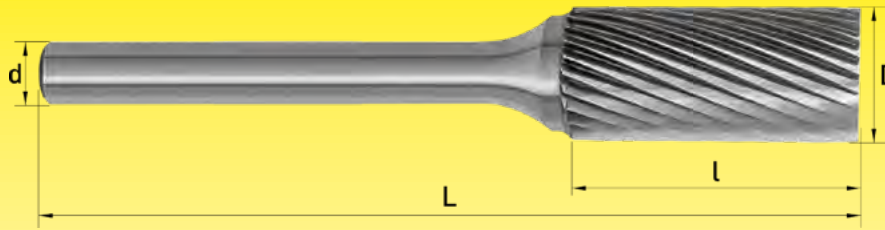

Одинарная заточка	Одинарная заточка TiAlN	D mm	l mm	L mm	d mm	ТИП ФРЕЗЫ	
VRB.A04013058M03SC	VRB.A04013058M03SC TiAlN	4	13	58	3	Цилиндрическая без торцевых зубьев ТИП А 	
VRB.A04016061M06SC	VRB.A04016061M06SC TiAlN	4	16	61	6		
VRB.A05013053M06SC	VRB.A05013053M06SC TiAlN	5	13	53	6		
VRB.A05016061M06SC	VRB.A05016061M06SC TiAlN	5	16	61	6		
VRB.A06013053M03SC	VRB.A06013053M03SC TiAlN	6	13	53	6		
VRB.A06016061M06SC	VRB.A06016061M06SC TiAlN	6	16	61	6		
VRB.A08018063M06SC	VRB.A08018063M06SC TiAlN	8	18	63	6		
VRB.A08020070M06SC	VRB.A08020070M06SC TiAlN	8	20	70	6		
VRB.A10020070M06SC	VRB.A10020070M06SC TiAlN	10	20	70	6		
VRB.A11025070M06SC	VRB.A11025070M06SC TiAlN	11	25	70	6		
VRB.A12025070M06SC	VRB.A12025070M06SC TiAlN	12	25	70	6		
VRB.A16025070M06SC	VRB.A16025070M06SC TiAlN	16	25	70	6		
VRB.A19013058M06SC	VRB.A19013058M06SC TiAlN	19	13	58	6		
VRB.A19019064M06SC	VRB.A19019064M06SC TiAlN	19	19	64	6		
VRB.A19025070M06SC	VRB.A19025070M06SC TiAlN	19	25	70	6		
VRB.A23025070M06SC	VRB.A23025070M06SC TiAlN	23	25	70	6		
VRB.A25025070M06SC	VRB.A25025070M06SC TiAlN	25	25	70	6		
VRB.B04013058M06SC	VRB.B04013058M06SC TiAlN	4	13	58	6		Цилиндрическая с торцевыми зубьями ТИП В
VRB.B05016061M06SC	VRB.B05016061M06SC TiAlN	5	16	61	6		
VRB.B06013058M03SC	VRB.B06013058M03SC TiAlN	6	13	58	3		
VRB.B06016061M06SC	VRB.B06016061M06SC TiAlN	6	16	61	6		
VRB.B08018063M06SC	VRB.B08018063M06SC TiAlN	8	18	63	6		
VRB.B08020065M06SC	VRB.B08020065M06SC TiAlN	8	20	65	6		
VRB.B10020063M06SC	VRB.B10020063M06SC TiAlN	10	20	63	6		
VRB.B11025070M06SC	VRB.B11025070M06SC TiAlN	11	25	70	6		
VRB.B12025070M06SC	VRB.B12025070M06SC TiAlN	12	25	70	6		
VRB.B16025070M06SC	VRB.B16025070M06SC TiAlN	16	25	70	6		
VRB.B19013058M06SC	VRB.B19013058M06SC TiAlN	19	13	58	6		
VRB.B19019064M06SC	VRB.B19019064M06SC TiAlN	19	19	64	6		
VRB.B19025070M06SC	VRB.B19025070M06SC TiAlN	19	25	70	6		
VRB.B23025070M06SC	VRB.B23025070M06SC TiAlN	23	25	70	6		
VRB.B25025070M06SC	VRB.B25025070M06SC TiAlN	25	25	70	6		

По заказу возможно изготовление борфрез с диаметром 8 мм, а также с другими видами заточки и удлиненным хвостовиком.

Одинарная заточка	Одинарная заточка TiAlN	D mm	l mm	L mm	d mm	ТИП ФРЕЗЫ	
VRB.C04013058M03SC	VRB.C04013058M03SC TiAlN	4	13	58	3	<p>Сфероцилиндрическая ТИП С</p> 	
VRB.C04016061M06SC	VRB.C04016061M06SC TiAlN	4	16	61	6		
VRB.C05013058M06SC	VRB.C05013058M06SC TiAlN	5	13	58	6		
VRB.C05016061M06SC	VRB.C05016061M06SC TiAlN	5	16	61	6		
VRB.C06013058M03SC	VRB.C06013058M03SC TiAlN	6	13	58	3		
VRB.C06016061M06SC	VRB.C06016061M06SC TiAlN	6	16	61	6		
VRB.C06018063M06SC	VRB.C06018063M06SC TiAlN	6	18	63	6		
VRB.C08018063M06SC	VRB.C08018063M06SC TiAlN	8	18	63	6		
VRB.C08020065M06SC	VRB.C08020065M06SC TiAlN	8	20	65	6		
VRB.C10020065M06SC	VRB.C10020065M06SC TiAlN	10	20	65	6		
VRB.C11025070M06SC	VRB.C11025070M06SC TiAlN	11	25	70	6		
VRB.C12025070M06SC	VRB.C12025070M06SC TiAlN	12	25	70	6		
VRB.C16025070M06SC	VRB.C16025070M06SC TiAlN	16	25	70	6		
VRB.C19025070M06SC	VRB.C19025070M06SC TiAlN	19	25	70	6		
VRB.C19013058M06SC	VRB.C19013058M06SC TiAlN	19	13	58	6		
VRB.C19019064M06SC	VRB.C19019064M06SC TiAlN	19	19	64	6		
VRB.C25025070M06SC	VRB.C25025070M06SC TiAlN	25	25	70	6		
VRB.D04003048M03SC	VRB.D04003048M03SC TiAlN	4	3	48	3		<p>Сферическая ТИП D</p> 
VRB.D05004049M03SC	VRB.D05004049M03SC TiAlN	5	4	49	3		
VRB.D06005060M03SC	VRB.D06005060M03SC TiAlN	6	5	60	3		
VRB.D06005050M06SC	VRB.D06005050M06SC TiAlN	6	5	50	6		
VRB.D08007052M06SC	VRB.D08007052M06SC TiAlN	8	7	52	6		
VRB.D10008053M06SC	VRB.D10008053M06SC TiAlN	10	8	53	6		
VRB.D11009054M06SC	VRB.D11009054M06SC TiAlN	11	9	54	6		
VRB.D12010055M06SC	VRB.D12010055M06SC TiAlN	12	10	55	6		
VRB.D16014059M06SC	VRB.D16014059M06SC TiAlN	16	14	59	6		
VRB.D19016061M06SC	VRB.D19016061M06SC TiAlN	19	16	61	6		
VRB.D25021066M06SC	VRB.D25021066M06SC TiAlN	25	21	66	6		
VRB.E04007052M03SC	VRB.E04007052M03SC TiAlN	4	7	52	3	<p>«Капля» ТИП E</p> 	
VRB.E05008053M03SC	VRB.E05008053M03SC TiAlN	5	8	53	3		
VRB.E06010055M03SC	VRB.E06010055M03SC TiAlN	6	10	55	3		
VRB.E06010055M06SC	VRB.E06010055M06SC TiAlN	6	10	55	6		
VRB.E08013058M06SC	VRB.E08013058M06SC TiAlN	8	13	58	6		
VRB.E10016061M06SC	VRB.E10016061M06SC TiAlN	10	16	61	6		
VRB.E12020065M06SC	VRB.E12020065M06SC TiAlN	12	20	65	6		
VRB.E16025070M06SC	VRB.E16025070M06SC TiAlN	16	25	70	6		
VRB.E19025070M06SC	VRB.E19025070M06SC TiAlN	19	25	70	6		
VRB.F04013058M03SC	VRB.F04013058M03SC TiAlN	4	13	58	3		<p>Гиперболическая со сферическим торцом ТИП F</p> 
VRB.F05013058M06SC	VRB.F05013058M06SC TiAlN	5	13	58	6		
VRB.F06013058M03SC	VRB.F06013058M03SC TiAlN	6	13	58	3		
VRB.F06013058M06SC	VRB.F06013058M06SC TiAlN	6	13	58	6		
VRB.F06016061M06SC	VRB.F06016061M06SC TiAlN	6	16	61	6		
VRB.F06018063M06SC	VRB.F06018063M06SC TiAlN	6	18	63	6		
VRB.F08018063M06SC	VRB.F08018063M06SC TiAlN	8	18	63	6		
VRB.F08020065M06SC	VRB.F08020065M06SC TiAlN	8	20	65	6		
VRB.F10020065M06SC	VRB.F10020065M06SC TiAlN	10	20	65	6		
VRB.F12020065M06SC	VRB.F12020065M06SC TiAlN	12	20	65	6		
VRB.F11025070M06SC	VRB.F11025070M06SC TiAlN	11	25	70	6		
VRB.F12025070M06SC	VRB.F12025070M06SC TiAlN	12	25	70	6		
VRB.F16025070M06SC	VRB.F16025070M06SC TiAlN	16	25	70	6		
VRB.F19025070M06SC	VRB.F19025070M06SC TiAlN	19	25	70	6		
VRB.F19032077M06SC	VRB.F19032077M06SC TiAlN	19	32	77	6		
VRB.F19038083M06SC	VRB.F19038083M06SC TiAlN	19	38	83	6		

По заказу возможно изготовление борфрез с диаметром 8 мм, а также с другими видами заточки и удлиненным хвостовиком.

Одинарная заточка	Одинарная заточка TiAlN	D mm	l mm	L mm	d mm	ТИП ФРЕЗЫ
VRB.G04013058M03SC	VRB.G04013058M03SC TiAlN	4	13	58	3	<p>«Снаряд» ТИП G</p>
VRB.G05013058M06SC	VRB.G05013058M06SC TiAlN	5	13	58	6	
VRB.G06013058M03SC	VRB.G06013058M03SC TiAlN	6	13	58	3	
VRB.G06016061M03SC	VRB.G06016061M03SC TiAlN	6	16	61	6	
VRB.G06018063M06SC	VRB.G06018063M06SC TiAlN	6	18	63	6	
VRB.G08018063M06SC	VRB.G08018063M06SC TiAlN	8	18	63	6	
VRB.G08020065M06SC	VRB.G08020065M06SC TiAlN	8	20	65	6	
VRB.G10020065M06SC	VRB.G10020065M06SC TiAlN	10	20	65	6	
VRB.G12020065M06SC	VRB.G12020065M06SC TiAlN	12	20	65	6	
VRB.G12025070M06SC	VRB.G12025070M06SC TiAlN	12	25	70	6	
VRB.G16025070M06SC	VRB.G16025070M06SC TiAlN	16	25	70	6	
VRB.G19025070M06SC	VRB.G19025070M06SC TiAlN	19	25	70	6	
VRB.G19038083M06SC	VRB.G19038083M06SC TiAlN	19	38	83	6	
VRB.H04013058M03SC	VRB.H04013058M03SC TiAlN	4	13	58	3	
VRB.H05009054M03SC	VRB.H05009054M03SC TiAlN	5	9	54	3	
VRB.H06018063M03SC	VRB.H06018063M03SC TiAlN	6	18	63	3	
VRB.H06018063M06SC	VRB.H06018063M06SC TiAlN	6	18	63	6	
VRB.H08020065M06SC	VRB.H08020065M06SC TiAlN	8	20	65	6	
VRB.H10025070M06SC	VRB.H10025070M06SC TiAlN	10	25	70	6	
VRB.H12032077M06SC	VRB.H12032077M06SC TiAlN	12	32	77	6	
VRB.H16036081M06SC	VRB.H16036081M06SC TiAlN	16	36	81	6	
VRB.H19041086M06SC	VRB.H19041086M06SC TiAlN	19	41	86	6	
VRB.J05006051M03SC	VRB.J05006051M03SC TiAlN	5	6	51	3	<p>Конус 60° ТИП J</p>
VRB.J06007052M03SC	VRB.J06007052M03SC TiAlN	6	7	52	3	
VRB.J06007052M06SC	VRB.J06007052M06SC TiAlN	6	7	52	6	
VRB.J08090053M06SC	VRB.J08090053M06SC TiAlN	8	9	53	6	
VRB.J10011055M06SC	VRB.J10011055M06SC TiAlN	10	11	55	6	
VRB.J12013057M06SC	VRB.J12013057M06SC TiAlN	12	13	57	6	
VRB.J16017061M06SC	VRB.J16017061M06SC TiAlN	16	17	61	6	
VRB.J19017061M06SC	VRB.J19017061M06SC TiAlN	19	17	61	6	
VRB.J25022066M06SC	VRB.J25022066M06SC TiAlN	25	22	66	6	<p>Конус 90° ТИП K</p>
VRB.K06003048M03SC	VRB.K06003048M03SC TiAlN	6	3	48	3	
VRB.K06003048M06SC	VRB.K06003048M06SC TiAlN	6	3	48	6	
VRB.K08004049M06SC	VRB.K08004049M06SC TiAlN	8	4	49	6	
VRB.K10005050M06SC	VRB.K10005050M06SC TiAlN	10	5	50	6	
VRB.K12006051M06SC	VRB.K12006051M06SC TiAlN	12	6	51	6	
VRB.K16008053M06SC	VRB.K16008053M06SC TiAlN	16	8	53	6	
VRB.K19010055M06SC	VRB.K19010055M06SC TiAlN	19	10	55	6	
VRB.L04013058M03SC	VRB.L04013058M03SC TiAlN	4	13	58	3	
VRB.L05013058M03SC	VRB.L05013058M03SC TiAlN	5	13	58	3	
VRB.L06013058M03SC	VRB.L06013058M03SC TiAlN	6	13	58	3	
VRB.L06016061M06SC	VRB.L06016061M06SC TiAlN	6	16	61	6	
VRB.L08022067M06SC	VRB.L08022067M06SC TiAlN	8	22	67	6	
VRB.L10025070M06SC	VRB.L10025070M06SC TiAlN	10	25	70	6	
VRB.L12028073M06SC	VRB.L12028073M06SC TiAlN	12	28	73	6	
VRB.L16030075M06SC	VRB.L16030075M06SC TiAlN	16	30	75	6	
VRB.L16033078M06SC	VRB.L16033078M06SC TiAlN	16	33	78	6	<p>Остроконическая ТИП M</p>
VRB.L19038083M06SC	VRB.L19038083M06SC TiAlN	19	38	83	6	
VRB.M04011056M03SC	VRB.M04011056M03SC TiAlN	4	11	56	3	
VRB.M05013058M03SC	VRB.M05013058M03SC TiAlN	5	13	58	3	
VRB.M06013058M03SC	VRB.M06013058M03SC TiAlN	6	13	58	3	
VRB.M06013058M06SC	VRB.M06013058M06SC TiAlN	6	13	58	6	
VRB.M06019063M06SC	VRB.M06019063M06SC TiAlN	6	19	63	6	
VRB.M06025070M07SC	VRB.M06025070M07SC TiAlN	6	25	70	7	
VRB.M10020065M06SC	VRB.M10020065M06SC TiAlN	10	20	65	6	
VRB.M12025070M06SC	VRB.M12025070M06SC TiAlN	12	25	70	6	
VRB.M16025070M06SC	VRB.M16025070M06SC TiAlN	16	25	70	6	
VRB.N05006051M03SC	VRB.N05006051M03SC TiAlN	5	6	51	3	
VRB.N06006051M03SC	VRB.N06006051M03SC TiAlN	6	6	51	3	
VRB.N06008053M06SC	VRB.N06008053M06SC TiAlN	6	8	53	6	
VRB.N10010055M06SC	VRB.N10010055M06SC TiAlN	10	10	55	6	
VRB.N12013058M06SC	VRB.N12013058M06SC TiAlN	12	13	58	6	
VRB.N16019064M06SC	VRB.N16019064M06SC TiAlN	16	19	64	6	
VRB.N19016061M06SC	VRB.N19016061M06SC TiAlN	19	16	61	6	

По заказу возможно изготовление борфрез с диаметром 8 мм, а также с другими видами заточки и удлиненным хвостовиком.

СИСТЕМА ОБОЗНАЧЕНИЙ

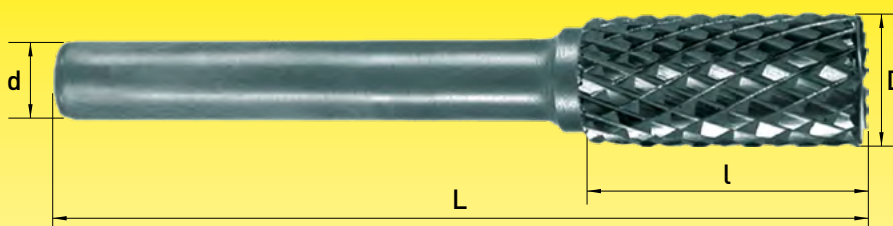

Двойная заточка	Двойная заточка TiAlN	D mm	l mm	L mm	d mm	ТИП ФРЕЗЫ
VRB.A04013058M03DC	VRB.A04013058M03DC TiAlN	4	13	58	3	<p>Цилиндрическая без торцевых зубьев</p> <p>ТИП А</p>
VRB.A04016061M06DC	VRB.A04016061M06DC TiAlN	4	16	61	6	
VRB.A05013053M06DC	VRB.A05013053M06DC TiAlN	5	13	53	6	
VRB.A05016061M06DC	VRB.A05016061M06DC TiAlN	5	16	61	6	
VRB.A06013053M03DC	VRB.A06013053M03DC TiAlN	6	13	53	6	
VRB.A06016061M06DC	VRB.A06016061M06DC TiAlN	6	16	61	6	
VRB.A08018063M06DC	VRB.A08018063M06DC TiAlN	8	18	63	6	
VRB.A08020070M06DC	VRB.A08020070M06DC TiAlN	8	20	70	6	
VRB.A10020070M06DC	VRB.A10020070M06DC TiAlN	10	20	70	6	
VRB.A11025070M06DC	VRB.A11025070M06DC TiAlN	11	25	70	6	
VRB.A12025070M06DC	VRB.A12025070M06DC TiAlN	12	25	70	6	
VRB.A16025070M06DC	VRB.A16025070M06DC TiAlN	16	25	70	6	
VRB.A19013058M06DC	VRB.A19013058M06DC TiAlN	19	13	58	6	
VRB.A19019064M06DC	VRB.A19019064M06DC TiAlN	19	19	64	6	
VRB.A19025070M06DC	VRB.A19025070M06DC TiAlN	19	25	70	6	
VRB.A23025070M06DC	VRB.A23025070M06DC TiAlN	23	25	70	6	
VRB.A25025070M06DC	VRB.A25025070M06DC TiAlN	25	25	70	6	
VRB.B04013058M06DC	VRB.B04013058M06DC TiAlN	4	13	58	6	
VRB.B05016061M06DC	VRB.B05016061M06DC TiAlN	5	16	61	6	
VRB.B06013058M03DC	VRB.B06013058M03DC TiAlN	6	13	58	3	
VRB.B06016061M06DC	VRB.B06016061M06DC TiAlN	6	16	61	6	
VRB.B08018063M06DC	VRB.B08018063M06DC TiAlN	8	18	63	6	
VRB.B08020065M06DC	VRB.B08020065M06DC TiAlN	8	20	65	6	
VRB.B10020063M06DC	VRB.B10020063M06DC TiAlN	10	20	63	6	
VRB.B11025070M06DC	VRB.B11025070M06DC TiAlN	11	25	70	6	
VRB.B12025070M06DC	VRB.B12025070M06DC TiAlN	12	25	70	6	
VRB.B16025070M06DC	VRB.B16025070M06DC TiAlN	16	25	70	6	
VRB.B19013058M06DC	VRB.B19013058M06DC TiAlN	19	13	58	6	
VRB.B19019064M06DC	VRB.B19019064M06DC TiAlN	19	19	64	6	
VRB.B19025070M06DC	VRB.B19025070M06DC TiAlN	19	25	70	6	
VRB.B23025070M06DC	VRB.B23025070M06DC TiAlN	23	25	70	6	
VRB.B25025070M06DC	VRB.B25025070M06DC TiAlN	25	25	70	6	

По заказу возможно изготовление борфрез с диаметром 8 мм, а также с другими видами заточки и удлиненным хвостовиком.

Двойная заточка	Двойная заточка TiAlN	D mm	l mm	L mm	d mm	ТИП ФРЕЗЫ	
VRB.C04013058M03DC	VRB.C04013058M03DC TiAlN	4	13	58	3	<p>Сфероцилиндрическая ТИП С</p>	
VRB.C04016061M06DC	VRB.C04016061M06DC TiAlN	4	16	61	6		
VRB.C05013058M06DC	VRB.C05013058M06DC TiAlN	5	13	58	6		
VRB.C05016061M06DC	VRB.C05016061M06DC TiAlN	5	16	61	6		
VRB.C06013058M03DC	VRB.C06013058M03DC TiAlN	6	13	58	3		
VRB.C06016061M06DC	VRB.C06016061M06DC TiAlN	6	16	61	6		
VRB.C06018063M06DC	VRB.C06018063M06DC TiAlN	6	18	63	6		
VRB.C08018063M06DC	VRB.C08018063M06DC TiAlN	8	18	63	6		
VRB.C08020065M06DC	VRB.C08020065M06DC TiAlN	8	20	65	6		
VRB.C10020065M06DC	VRB.C10020065M06DC TiAlN	10	20	65	6		
VRB.C11025070M06DC	VRB.C11025070M06DC TiAlN	11	25	70	6		
VRB.C12025070M06DC	VRB.C12025070M06DC TiAlN	12	25	70	6		
VRB.C16025070M06DC	VRB.C16025070M06DC TiAlN	16	25	70	6		
VRB.C19025070M06DC	VRB.C19025070M06DC TiAlN	19	25	70	6		
VRB.C19013058M06DC	VRB.C19013058M06DC TiAlN	19	13	58	6		
VRB.C19019064M06DC	VRB.C19019064M06DC TiAlN	19	19	64	6		
VRB.C25025070M06DC	VRB.C25025070M06DC TiAlN	25	25	70	6		
VRB.D04003048M03DC	VRB.D04003048M03DC TiAlN	4	3	48	3		<p>Сферическая ТИП D</p>
VRB.D05004049M03DC	VRB.D05004049M03DC TiAlN	5	4	49	3		
VRB.D06005060M03DC	VRB.D06005060M03DC TiAlN	6	5	60	3		
VRB.D06005050M06DC	VRB.D06005050M06DC TiAlN	6	5	50	6		
VRB.D08007052M06DC	VRB.D08007052M06DC TiAlN	8	7	52	6		
VRB.D10008053M06DC	VRB.D10008053M06DC TiAlN	10	8	53	6		
VRB.D11009054M06DC	VRB.D11009054M06DC TiAlN	11	9	54	6		
VRB.D12010055M06DC	VRB.D12010055M06DC TiAlN	12	10	55	6		
VRB.D16014059M06DC	VRB.D16014059M06DC TiAlN	16	14	59	6		
VRB.D19016061M06DC	VRB.D19016061M06DC TiAlN	19	16	61	6		
VRB.D25021066M06DC	VRB.D25021066M06DC TiAlN	25	21	66	6		
VRB.E04007052M03DC	VRB.E04007052M03DC TiAlN	4	7	52	3	<p>«Капля» ТИП E</p>	
VRB.E05008053M03DC	VRB.E05008053M03DC TiAlN	5	8	53	3		
VRB.E06010055M03DC	VRB.E06010055M03DC TiAlN	6	10	55	3		
VRB.E06010055M06DC	VRB.E06010055M06DC TiAlN	6	10	55	6		
VRB.E08013058M06DC	VRB.E08013058M06DC TiAlN	8	13	58	6		
VRB.E10016061M06DC	VRB.E10016061M06DC TiAlN	10	16	61	6		
VRB.E12020065M06DC	VRB.E12020065M06DC TiAlN	12	20	65	6		
VRB.E16025070M06DC	VRB.E16025070M06DC TiAlN	16	25	70	6		
VRB.E19025070M06DC	VRB.E19025070M06DC TiAlN	19	25	70	6		
VRB.F04013058M03DC	VRB.F04013058M03DC TiAlN	4	13	58	3	<p>Гиперболическая со сферическим торцом ТИП F</p>	
VRB.F05013058M06DC	VRB.F05013058M06DC TiAlN	5	13	58	6		
VRB.F06013058M03DC	VRB.F06013058M03DC TiAlN	6	13	58	3		
VRB.F06013058M06DC	VRB.F06013058M06DC TiAlN	6	13	58	6		
VRB.F06016061M06DC	VRB.F06016061M06DC TiAlN	6	16	61	6		
VRB.F06018063M06DC	VRB.F06018063M06DC TiAlN	6	18	63	6		
VRB.F08018063M06DC	VRB.F08018063M06DC TiAlN	8	18	63	6		
VRB.F08020065M06DC	VRB.F08020065M06DC TiAlN	8	20	65	6		
VRB.F10020065M06DC	VRB.F10020065M06DC TiAlN	10	20	65	6		
VRB.F12020065M06DC	VRB.F12020065M06DC TiAlN	12	20	65	6		
VRB.F11025070M06DC	VRB.F11025070M06DC TiAlN	11	25	70	6		
VRB.F12025070M06DC	VRB.F12025070M06DC TiAlN	12	25	70	6		
VRB.F16025070M06DC	VRB.F16025070M06DC TiAlN	16	25	70	6		
VRB.F19025070M06DC	VRB.F19025070M06DC TiAlN	19	25	70	6		
VRB.F19032077M06DC	VRB.F19032077M06DC TiAlN	19	32	77	6		
VRB.F19038083M06DC	VRB.F19038083M06DC TiAlN	19	38	83	6		

По заказу возможно изготовление борфрез с диаметром 8 мм, а также с другими видами заточки и удлиненным хвостовиком.

Двойная заточка	Двойная заточка TiAlN	D mm	l mm	L mm	d mm	ТИП ФРЕЗЫ	
VRB.G04013058M03DC	VRB.G04013058M03DC TiAlN	4	13	58	3	<p>«Снаряд» ТИП G</p>	
VRB.G05013058M06DC	VRB.G05013058M06DC TiAlN	5	13	58	6		
VRB.G06013058M03DC	VRB.G06013058M03DC TiAlN	6	13	58	3		
VRB.G06016061M03DC	VRB.G06016061M03DC TiAlN	6	16	61	6		
VRB.G06018063M06DC	VRB.G06018063M06DC TiAlN	6	18	63	6		
VRB.G08018063M06DC	VRB.G08018063M06DC TiAlN	8	18	63	6		
VRB.G08020065M06DC	VRB.G08020065M06DC TiAlN	8	20	65	6		
VRB.G10020065M06DC	VRB.G10020065M06DC TiAlN	10	20	65	6		
VRB.G12020065M06DC	VRB.G12020065M06DC TiAlN	12	20	65	6		
VRB.G12025070M06DC	VRB.G12025070M06DC TiAlN	12	25	70	6		
VRB.G16025070M06DC	VRB.G16025070M06DC TiAlN	16	25	70	6		
VRB.G19025070M06DC	VRB.G19025070M06DC TiAlN	19	25	70	6		
VRB.G19038083M06DC	VRB.G19038083M06DC TiAlN	19	38	83	6		
VRB.H04013058M03DC	VRB.H04013058M03DC TiAlN	4	13	58	3		<p>«Пламя» ТИП H</p>
VRB.H05009054M03DC	VRB.H05009054M03DC TiAlN	5	9	54	3		
VRB.H06018063M03DC	VRB.H06018063M03DC TiAlN	6	18	63	3		
VRB.H06018063M06DC	VRB.H06018063M06DC TiAlN	6	18	63	6		
VRB.H08020065M06DC	VRB.H08020065M06DC TiAlN	8	20	65	6		
VRB.H10025070M06DC	VRB.H10025070M06DC TiAlN	10	25	70	6		
VRB.H12032077M06DC	VRB.H12032077M06DC TiAlN	12	32	77	6		
VRB.H16036081M06DC	VRB.H16036081M06DC TiAlN	16	36	81	6		
VRB.H19041086M06DC	VRB.H19041086M06DC TiAlN	19	41	86	6		
VRB.J05006051M03DC	VRB.J05006051M03DC TiAlN	5	6	51	3	<p>Конус 60° ТИП J</p>	
VRB.J06007052M03DC	VRB.J06007052M03DC TiAlN	6	7	52	3		
VRB.J06007052M06DC	VRB.J06007052M06DC TiAlN	6	7	52	6		
VRB.J08090053M06DC	VRB.J08090053M06DC TiAlN	8	9	53	6		
VRB.J10011055M06DC	VRB.J10011055M06DC TiAlN	10	11	55	6		
VRB.J12013057M06DC	VRB.J12013057M06DC TiAlN	12	13	57	6		
VRB.J16017061M06DC	VRB.J16017061M06DC TiAlN	16	17	61	6		
VRB.J19017061M06DC	VRB.J19017061M06DC TiAlN	19	17	61	6		
VRB.J25022066M06DC	VRB.J25022066M06DC TiAlN	25	22	66	6		
VRB.K06003048M03DC	VRB.K06003048M03DC TiAlN	6	3	48	3		<p>Конус 90° ТИП K</p>
VRB.K06003048M06DC	VRB.K06003048M06DC TiAlN	6	3	48	6		
VRB.K08004049M06DC	VRB.K08004049M06DC TiAlN	8	4	49	6		
VRB.K10005050M06DC	VRB.K10005050M06DC TiAlN	10	5	50	6		
VRB.K12006051M06DC	VRB.K12006051M06DC TiAlN	12	6	51	6		
VRB.K16008053M06DC	VRB.K16008053M06DC TiAlN	16	8	53	6		
VRB.K19010055M06DC	VRB.K19010055M06DC TiAlN	19	10	55	6		
VRB.K25013058M06DC	VRB.K25013058M06DC TiAlN	25	13	58	6		
VRB.L04013058M03DC	VRB.L04013058M03DC TiAlN	4	13	58	3	<p>Сфероконическая ТИП L</p>	
VRB.L05013058M03DC	VRB.L05013058M03DC TiAlN	5	13	58	3		
VRB.L06013058M03DC	VRB.L06013058M03DC TiAlN	6	13	58	3		
VRB.L06016061M06DC	VRB.L06016061M06DC TiAlN	6	16	61	6		
VRB.L08022067M06DC	VRB.L08022067M06DC TiAlN	8	22	67	6		
VRB.L10025070M06DC	VRB.L10025070M06DC TiAlN	10	25	70	6		
VRB.L12028073M06DC	VRB.L12028073M06DC TiAlN	12	28	73	6		
VRB.L16030075M06DC	VRB.L16030075M06DC TiAlN	16	30	75	6		
VRB.L16033078M06DC	VRB.L16033078M06DC TiAlN	16	33	78	6		
VRB.L19038083M06DC	VRB.L19038083M06DC TiAlN	19	38	83	6		<p>Остроконическая ТИП M</p>
VRB.M04011056M03DC	VRB.M04011056M03DC TiAlN	4	11	56	3		
VRB.M05013058M03DC	VRB.M05013058M03DC TiAlN	5	13	58	3		
VRB.M06013058M03DC	VRB.M06013058M03DC TiAlN	6	13	58	3		
VRB.M06013058M06DC	VRB.M06013058M06DC TiAlN	6	13	58	6		
VRB.M06019063M06DC	VRB.M06019063M06DC TiAlN	6	19	63	6		
VRB.M06025070M07DC	VRB.M06025070M07DC TiAlN	6	25	70	7		
VRB.M10020065M06DC	VRB.M10020065M06DC TiAlN	10	20	65	6		
VRB.M12025070M06DC	VRB.M12025070M06DC TiAlN	12	25	70	6		
VRB.M16025070M06DC	VRB.M16025070M06DC TiAlN	16	25	70	6	<p>С обратным конусом ТИП N</p>	
VRB.N05006051M03DC	VRB.N05006051M03DC TiAlN	5	6	51	3		
VRB.N06006051M03DC	VRB.N06006051M03DC TiAlN	6	6	51	3		
VRB.N06008053M06DC	VRB.N06008053M06DC TiAlN	6	8	53	6		
VRB.N10010055M06DC	VRB.N10010055M06DC TiAlN	10	10	55	6		
VRB.N12013058M06DC	VRB.N12013058M06DC TiAlN	12	13	58	6		
VRB.N16019064M06DC	VRB.N16019064M06DC TiAlN	16	19	64	6		
VRB.N19016061M06DC	VRB.N19016061M06DC TiAlN	19	16	61	6		

По заказу возможно изготовление борфрез с диаметром 8 мм, а также с другими видами заточки и удлиненным хвостовиком.

СИСТЕМА ОБОЗНАЧЕНИЙ

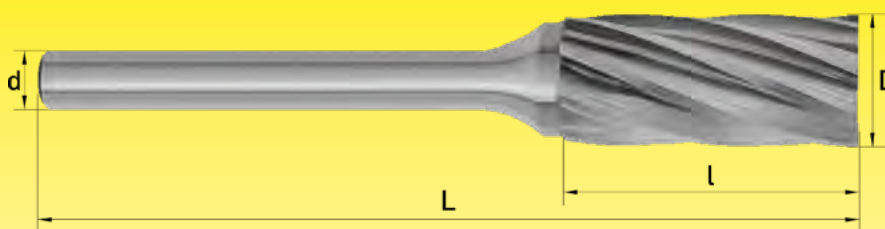
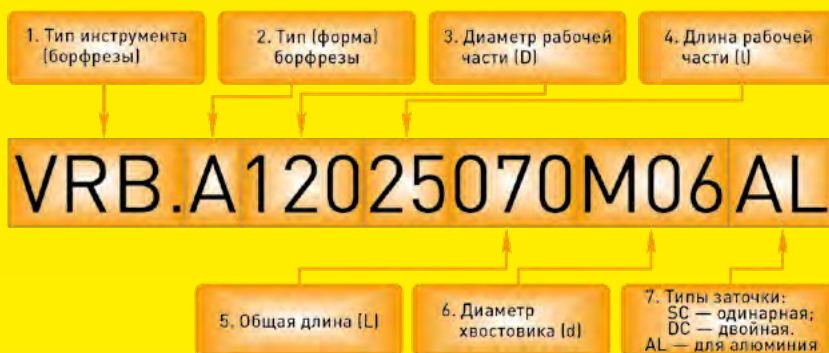

AL	D mm	l mm	L mm	d mm	ТИП ФРЕЗЫ	
VRB.A04013058M03 AL	4	13	58	3	<p>Цилиндрическая без торцевых зубьев</p> <p>ТИП А</p>	
VRB.A04016061M06 AL	4	16	61	6		
VRB.A05013053M06 AL	5	13	53	6		
VRB.A05016061M06 AL	5	16	61	6		
VRB.A06013053M03 AL	6	13	53	6		
VRB.A06016061M06 AL	6	16	61	6		
VRB.A08018063M06 AL	8	18	63	6		
VRB.A08020070M06 AL	8	20	70	6		
VRB.A10020070M06 AL	10	20	70	6		
VRB.A11025070M06 AL	11	25	70	6		
VRB.A12025070M06 AL	12	25	70	6		
VRB.A16025070M06 AL	16	25	70	6		
VRB.A19013058M06 AL	19	13	58	6		
VRB.A19019064M06 AL	19	19	64	6		
VRB.A19025070M06 AL	19	25	70	6		
VRB.A23025070M06 AL	23	25	70	6		
VRB.A25025070M06 AL	25	25	70	6		
VRB.B04013058M06 AL	4	13	58	6		<p>Цилиндрическая с торцевыми зубьями</p> <p>ТИП В</p>
VRB.B05016061M06 AL	5	16	61	6		
VRB.B06013058M03 AL	6	13	58	3		
VRB.B06016061M06 AL	6	16	61	6		
VRB.B08018063M06 AL	8	18	63	6		
VRB.B08020065M06 AL	8	20	65	6		
VRB.B10020063M06 AL	10	20	63	6		
VRB.B11025070M06 AL	11	25	70	6		
VRB.B12025070M06 AL	12	25	70	6		
VRB.B16025070M06 AL	16	25	70	6		
VRB.B19013058M06 AL	19	13	58	6		
VRB.B19019064M06 AL	19	19	64	6		
VRB.B19025070M06 AL	19	25	70	6		
VRB.B23025070M06 AL	23	25	70	6		
VRB.B25025070M06 AL	25	25	70	6		

По заказу возможно изготовление борфрез с диаметром 8 мм, а также с другими видами заточки и удлиненным хвостовиком.

AL	D mm	L mm	L mm	d mm	ТИП ФРЕЗЫ	
VRB.C04013058M03 AL	4	13	58	3	Сфероцилиндрическая ТИП С 	
VRB.C04016061M06 AL	4	16	61	6		
VRB.C05013058M06 AL	5	13	58	6		
VRB.C05016061M06 AL	5	16	61	6		
VRB.C06013058M03 AL	6	13	58	3		
VRB.C06016061M06 AL	6	16	61	6		
VRB.C06018063M06 AL	6	18	63	6		
VRB.C08018063M06 AL	8	18	63	6		
VRB.C08020065M06 AL	8	20	65	6		
VRB.C10020065M06 AL	10	20	65	6		
VRB.C11025070M06 AL	11	25	70	6		
VRB.C12025070M06 AL	12	25	70	6		
VRB.C16025070M06 AL	16	25	70	6		
VRB.C19025070M06 AL	19	25	70	6		
VRB.C19013058M06 AL	19	13	58	6		
VRB.C19019064M06 AL	19	19	64	6		
VRB.C25025070M06 AL	25	25	70	6		
VRB.D04003048M03 AL	4	3	48	3		Сферическая ТИП D 
VRB.D05004049M03 AL	5	4	49	3		
VRB.D06005060M03 AL	6	5	60	3		
VRB.D06005050M06 AL	6	5	50	6		
VRB.D08007052M06 AL	8	7	52	6		
VRB.D10008053M06 AL	10	8	53	6		
VRB.D11009054M06 AL	11	9	54	6		
VRB.D12010055M06 AL	12	10	55	6		
VRB.D16014059M06 AL	16	14	59	6		
VRB.D19016061M06 AL	19	16	61	6		
VRB.D25021066M06 AL	25	21	66	6		
VRB.E04007052M03 AL	4	7	52	3	«Капля» ТИП E 	
VRB.E05008053M03 AL	5	8	53	3		
VRB.E06010055M03 AL	6	10	55	3		
VRB.E06010055M06 AL	6	10	55	6		
VRB.E08013058M06 AL	8	13	58	6		
VRB.E10016061M06 AL	10	16	61	6		
VRB.E12020065M06 AL	12	20	65	6		
VRB.E16025070M06 AL	16	25	70	6		
VRB.E19025070M06 AL	19	25	70	6		
VRB.F04013058M03 AL	4	13	58	3		Гиперболическая со сферическим торцом ТИП F 
VRB.F05013058M06 AL	5	13	58	6		
VRB.F06013058M03 AL	6	13	58	3		
VRB.F06013058M06 AL	6	13	58	6		
VRB.F06016061M06 AL	6	16	61	6		
VRB.F06018063M06 AL	6	18	63	6		
VRB.F08018063M06 AL	8	18	63	6		
VRB.F08020065M06 AL	8	20	65	6		
VRB.F10020065M06 AL	10	20	65	6		
VRB.F12020065M06 AL	12	20	65	6		
VRB.F11025070M06 AL	11	25	70	6		
VRB.F12025070M06 AL	12	25	70	6		
VRB.F16025070M06 AL	16	25	70	6		
VRB.F19025070M06 AL	19	25	70	6		
VRB.F19032077M06 AL	19	32	77	6		
VRB.F19038083M06 AL	19	38	83	6		

По заказу возможно изготовление борфрез с диаметром 8 мм, а также с другими видами заточки и удлиненным хвостовиком.

AL	D mm	l mm	L mm	d mm	ТИП ФРЕЗЫ	
VRB.G04013058M03 AL	4	13	58	3	<p>«Снаряд» ТИП G</p>	
VRB.G05013058M06 AL	5	13	58	6		
VRB.G06013058M03 AL	6	13	58	3		
VRB.G06016061M03 AL	6	16	61	6		
VRB.G06018063M06 AL	6	18	63	6		
VRB.G08018063M06 AL	8	18	63	6		
VRB.G08020065M06 AL	8	20	65	6		
VRB.G10020065M06 AL	10	20	65	6		
VRB.G12020065M06 AL	12	20	65	6		
VRB.G12025070M06 AL	12	25	70	6		
VRB.G16025070M06 AL	16	25	70	6		
VRB.G19025070M06 AL	19	25	70	6		
VRB.G19038083M06 AL	19	38	83	6		
VRB.H04013058M03 AL	4	13	58	3		<p>«Пламя» ТИП H</p>
VRB.H05009054M03 AL	5	9	54	3		
VRB.H06018063M03 AL	6	18	63	3		
VRB.H06018063M06 AL	6	18	63	6		
VRB.H08020065M06 AL	8	20	65	6		
VRB.H10025070M06 AL	10	25	70	6		
VRB.H12032077M06 AL	12	32	77	6		
VRB.H16036081M06 AL	16	36	81	6		
VRB.H19041086M06 AL	19	41	86	6		
VRB.J05006051M03 AL	5	6	51	3	<p>Конус 60° ТИП J</p>	
VRB.J06007052M03 AL	6	7	52	3		
VRB.J06007052M06 AL	6	7	52	6		
VRB.J08090053M06 AL	8	9	53	6		
VRB.J10011055M06 AL	10	11	55	6		
VRB.J12013057M06 AL	12	13	57	6		
VRB.J16017061M06 AL	16	17	61	6		
VRB.J19017061M06 AL	19	17	61	6		
VRB.J25022066M06 AL	25	22	66	6		
VRB.K06003048M03 AL	6	3	48	3		<p>Конус 90° ТИП K</p>
VRB.K06003048M06 AL	6	3	48	6		
VRB.K08004049M06 AL	8	4	49	6		
VRB.K10005050M06 AL	10	5	50	6		
VRB.K12006051M06 AL	12	6	51	6		
VRB.K16008053M06 AL	16	8	53	6		
VRB.K19010055M06 AL	19	10	55	6		
VRB.K25013058M06 AL	25	13	58	6		
VRB.L04013058M03 AL	4	13	58	3	<p>Сфероконическая ТИП L</p>	
VRB.L05013058M03 AL	5	13	58	3		
VRB.L06013058M03 AL	6	13	58	3		
VRB.L06016061M06 AL	6	16	61	6		
VRB.L08022067M06 AL	8	22	67	6		
VRB.L10025070M06 AL	10	25	70	6		
VRB.L12028073M06 AL	12	28	73	6		
VRB.L16030075M06 AL	16	30	75	6		
VRB.L16033078M06 AL	16	33	78	6		
VRB.L19038083M06 AL	19	38	83	6		
VRB.M04011056M03 AL	4	11	56	3	<p>Остроконическая ТИП M</p>	
VRB.M05013058M03 AL	5	13	58	3		
VRB.M06013058M03 AL	6	13	58	3		
VRB.M06013058M06 AL	6	13	58	6		
VRB.M06019063M06 AL	6	19	63	6		
VRB.M06025070M07 AL	6	25	70	7		
VRB.M10020065M06 AL	10	20	65	6		
VRB.M12025070M06 AL	12	25	70	6		
VRB.M16025070M06 AL	16	25	70	6		
VRB.N05006051M03 AL	5	6	51	3		<p>С обратным конусом ТИП N</p>
VRB.N06006051M03 AL	6	6	51	3		
VRB.N06008053M06 AL	6	8	53	6		
VRB.N10010055M06 AL	10	10	55	6		
VRB.N12013058M06 AL	12	13	58	6		
VRB.N16019064M06 AL	16	19	64	6		
VRB.N19016061M06 AL	19	16	61	6		

По заказу возможно изготовление борфрез с диаметром 8 мм, а также с другими видами заточки и удлиненным хвостовиком.